

Operating Manual
ALTAIR[®] 4X
Multigas Detector





Declaration of Conformity

Manufactured by: Mine Safety Appliances Company
1000 Cranberry Woods Drive
Cranberry Township, PA 16066 USA

European authorized representative:

MSA AUER GmbH
Thiemannstrasse 1
D-12059 Berlin

We declare that the

MSA ALTAIR 4X

complies with the provisions of the council directive 94/9/EC [ATEX]. This declaration is based on the EC-Type Examination Certificate FTZU 07 ATEX 0169 X in accordance with Annex III of the ATEX Directive 94/9/EC. Quality Assurance Notification issued by Ineris, Notified Body number 0080, in accordance with Annex IV of the ATEX Directive 94/9/EC.

We additionally declare that this product is in conformance with the EMC Directive 2004/108/EC in accordance with the standards

DIN EN 50270:2006 Typ 2 and DIN EN 61000-6-3:2007

MSA AUER GmbH
Dr. Axel Schubert
R&D Instruments

Berlin, May 2010

Contents

1	Safety Regulations	6
1.1	Correct Use	6
1.2	Liability Information	7
1.3	Safety and Precautionary Measures to be Adopted	7
2	Description	10
2.1	Overview	10
2.2	Device Hardware Interfaces	11
2.3	On-Screen Indicators	13
2.4	Battery Care	14
2.5	Viewing Optional Displays	16
2.6	Sensor Missing Alarm	20
2.7	Sensor End of Life Warning	20
2.8	Sensor End of Life Indicator	20
2.9	Monitoring Toxic Gases	20
2.10	Monitoring the Oxygen Concentration	22
2.11	Monitoring Combustible Gases	23
3	Operation	24
3.1	Environmental Factors	24
3.2	Turning on the Device	25
3.3	Measurement Mode [Normal Operation]	30
3.4	Device Setup	32
3.5	Data Logging	36
3.6	Function Tests	37
3.7	Safe LED	37
3.8	Bump Test	37
3.9	Calibration	39

4	Maintenance	44
4.1	Troubleshooting	45
4.2	Live Maintenance Procedure - Replacing and Adding a Sensor	46
4.3	Cleaning	48
4.4	Storage	48
4.5	Scope of Delivery	48
5	Technical Specifications/Certifications	49
5.1	Technical Specifications	49
5.2	Factory-set Alarm thresholds	50
5.3	Certification	51
5.4	Performance Specification	53
5.5	XCell Sensor Patents	54
6	Ordering Information	55
7	Appendix	56
7.1	Start Up Sequence [Power on]	56
7.2	Fresh Air Setup [FAS]	57
7.3	Reset Screen Controls	58
7.4	Bump Test	60
7.5	Options Setup	61
7.6	Sensor Setup	62
7.7	Calibrations	63

1 Safety Regulations

1.1 Correct Use

The ALTAIR 4X Multigas Detector is intended for use by trained and qualified personnel. It is designed to be used when performing a hazard assessment to:

- assess potential worker exposure to combustible and toxic gases and vapours as well as low level of oxygen.
- determine the appropriate gas and vapour monitoring needed for a workplace.

The ALTAIR 4X Multigas Detector can be equipped to detect:

- Combustible gases and certain combustible vapours
- Oxygen-deficient or oxygen-rich atmospheres
- Specific toxic gases for which a sensor is installed.



While the device can detect up to 30 % oxygen in ambient air, it is approved for use only up to 21 % oxygen.

It is imperative that this operating manual be read and observed when using the product. In particular, the safety instructions, as well as the information for the use and operation of the product, must be carefully read and observed. Furthermore, the national regulations applicable in the user's country must be taken into account for a safe use.



Danger!

This product is supporting life and health. Inappropriate use, maintenance or servicing may affect the function of the device and thereby seriously compromise the user's life.

Before use the product operability must be verified. The product must not be used if the function test is unsuccessful, it is damaged, a competent servicing/maintenance has not been made, genuine MSA spare parts have not been used.

Alternative use, or use outside this specification will be considered as non-compliance. This also applies especially to unauthorised alterations to the product and to commissioning work that has not been carried out by MSA or authorised persons.

1.2 Liability Information

MSA accepts no liability in cases where the product has been used inappropriately or not as intended. The selection and use of the product are the exclusive responsibility of the individual operator.

Product liability claims, warranties also as guarantees made by MSA with respect to the product are voided, if it is not used, serviced or maintained in accordance with the instructions in this manual.

1.3 Safety and Precautionary Measures to be Adopted



Attention!

The following safety instructions must be observed implicitly. Only in this way can the safety and health of the individual operators, and the correct functioning of the device, be guaranteed.

Check function each day before use

Before each use, check the function and calibration of the device. Otherwise there is a danger that incorrect results will be displayed. The check is performed using a suitable calibration gas.

Perform a bump test each day before use

Perform a bump test before each day's use to verify proper operation. The device must pass the bump test. If it fails the test, perform a calibration before using the device.

Perform a bump test more frequently if the device is subjected to physical shock or high levels of contaminants. Also, perform a bump test more frequently if the tested atmosphere contains the following materials, which may desensitize the combustible gas sensor and reduce its readings:

- Organic silicones
- Silicates
- Lead-containing compounds
- Hydrogen sulphide exposures over 200 ppm or exposures over 50 ppm for one minute.

Check minimum concentration of a combustible gas

The minimum concentration of a combustible gas in air that can ignite is defined as the Lower Explosive Limit [LEL]. A combustible gas reading of "XXX" indicates the atmosphere is above 100 % LEL or 5.00 % vol CH₄, and an explosion hazard exists. Move away from hazardous area immediately.

Observe atmosphere

Do not use the device to test for combustible or toxic gases in the following atmospheres as this may result in erroneous readings:

- Oxygen-deficient or oxygen-rich atmospheres
- Reducing atmospheres
- Furnace stacks
- Inert environments
- Atmospheres containing combustible airborne mists/dusts.

Use the device only to detect gases/vapours for which a sensor is installed.

Make sure adequate oxygen is present.

Not to be used for gases having a flashpoint in excess of 38 °C

Do not use the device to test for combustible gases in atmospheres containing vapours from liquids with a high flash point [above 38 °C], as this may result in erroneously low readings.

Physical shock

Recheck calibration if device is subjected to physical shock.

Sensor maintenance

Do not block sensor openings as this may cause inaccurate readings. Do not press on the face of the sensors, as this may damage them and cause erroneous readings. Do not use compressed air to clean the sensor holes, as the pressure may damage the sensors.

Observe proper time for display stabilising

Allow sufficient time for device to display accurate reading. Response times vary based on the type of sensor being utilized.

Observe proper battery maintenance

Use only battery chargers made available by MSA for use with this device; other chargers may damage the battery pack and the device. Dispose of in accordance with local health and safety regulations.

Use of the GALAXY Automated Test System is an alternate approved method for charging ALTAIR 4X devices.

Be aware of environmental conditions

A number of environmental factors may affect the sensor readings, including changes in pressure, humidity and temperature.

Pressure and humidity changes also affect the amount of oxygen actually present in the atmosphere.

Be aware of the procedures for handling electrostatically sensitive electronics

The device contains electrostatically sensitive components. Do not open or repair the device without using appropriate electrostatic discharge [ESD] protection. The warranty does not cover damage caused by electrostatic discharges.

Be aware of the product regulations

Follow all relevant national regulations applicable in the country of use.

Be aware of the warranty regulations

The warranties made by Mine Safety Appliances Company with respect to the product are voided if the product is not used and maintained in accordance with the instructions in this manual. Please protect yourself and others by following them. We encourage our customers to write or call regarding this equipment prior to use or for any additional information relative to use or service.

2 Description

2.1 Overview

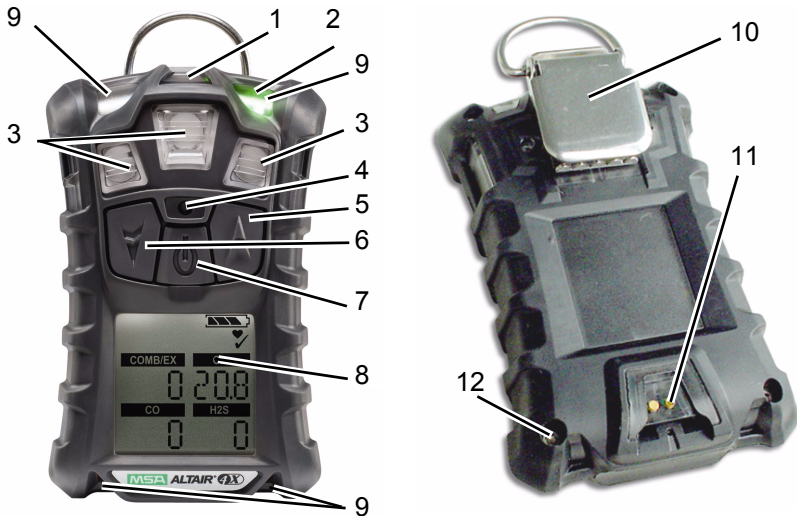

Fig. 1 device view

- | | | | |
|---|---|----|------------------------|
| 1 | MSA link Communication | 8 | Display |
| 2 | Safe LED [green] and Fault LED [yellow] | 9 | Alarm LEDs [4] |
| 3 | Sensor Inlets | 10 | Belt Clip |
| 4 | Horn | 11 | Charging Connection |
| 5 | ▼ Button | 12 | Screws [4] |
| 6 | ▲ Button | 13 | Charge LED [red/green] |
| 7 | ON/OFF Button | | |

The device monitors gases in ambient air and in the workplace.

It is available with a maximum of three sensors, which can display readings for four separate gases [one Dual Toxic Sensor provides both CO and H₂S sensing capabilities in a single sensor].



While the device can detect up to 30 % oxygen in ambient air, it is approved for use only up to 21 % oxygen.

The alarm levels for the individual gases are factory-set and can be changed through the Setup Menu. These changes can also be made through MSA Link software. Ensure that the latest version of the MSA Link software has been downloaded from MSA's website www.msanet.com.



If gas is present during Fresh Air Setup, the device will fail and enters Measure mode.

2.2 Device Hardware Interfaces

Device operation is dialog driven from the display with the aid of the three function buttons [→ Fig. 1].

Button Definitions

Button	Description
ON/OFF	The ON/OFF button is used to turn device on or off and to confirm user action selections. When the ▲ button and the ON/OFF button are pressed simultaneously for device start-up, the Options Setup Mode displays.
▼	The ▼ button is used to move forward through data screens in measuring mode, or as page back and to decrease the values in set-up mode. Holding this button for 3 seconds while in Normal Measure Mode will activate the InstantAlert alarm.
▲	The ▲ button is used to reset peak, STEL TWA and acknowledge alarms [where possible] or access calibration in measuring mode. It is also used as page up or to increase the values in set-up mode.

LED Definitions

LED	Description
GREEN	The Safe LED flashes once every 15 seconds to notify the user that the device is on and operating. This option can be turned off through the MSA Link software.
RED	The red LEDs are visual indications of an alarm condition or any type of error in the device.
YELLOW	The yellow LED is a visual indication of an device fault condition. This LED will be on with the following conditions: <ul style="list-style-type: none"> - Device memory error - Sensor Missing - Sensor Error
RED/GREEN	The Charge LED is a visual indication of charge status. <ul style="list-style-type: none"> - RED: <ul style="list-style-type: none"> is charging - GREEN: complete charge

Vibrating Alarm

The device is equipped with a vibrating alarm.

Backlight

The backlight automatically activates when any button is pressed. The backlight remains on for the duration of the user-selected timeout. This on/off duration can be set through MSA Link software.

Horn

The horn provides an audible alarm.

Operating Beep

This operating beep activates every 30 seconds by momentarily beeping the horn and flashing the alarm LEDs under the following conditions:

- Operating beep is enabled
- Device is on normal Measure Gases page
- Device is not in battery warning
- Device is not in gas alarm
- Audible and visual options are enabled

2.3 On-Screen Indicators

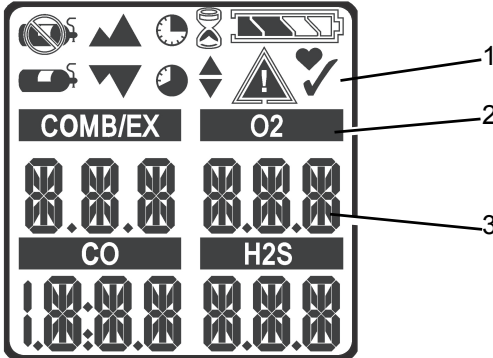

Fig. 2 Display

1 Graphic Symbols

3 Gas Concentration

2 Gas Type



Alarm Symbol – Indicates alarm state.



Motion Alert – Indicates Motion Alert is active.



Bump Check Symbol – Indicates successful bump or cal.



Indicates required interaction.



Battery Condition – Indicates the battery charge level.



Sensor Labels.



Cal Gas Cylinder – Indicates cal gas must be applied.



No Gas Cylinder – Indicates cal gas should not be applied and device must be exposed to fresh air.



Hourglass – Indicates user should wait.



Minimum – Indicates a minimum value or low alarm.



PEAK Symbol – Indicates a PEAK reading or high alarm.



STEL Symbol – Indicates a STEL alarm.



TWA Symbol – Indicates a TWA alarm.



Sensor life Symbol – Indicates the end of sensor life

2.4 Battery Care

Battery Life Indicator

The battery condition icon is continuously displayed in the upper right-hand corner of the display. As the battery is depleted, battery icon segments blank until only the battery icon outline remains.

Each indicator segment represents approximately 25 % of the total battery capacity.

Battery Warning



Attention!

If battery warning alarm activates while using the device, leave the area immediately as the end of battery life is approaching.

Failure to follow this warning can result in serious personal injury or death.

The nominal run-time of the device at room temperature is 24 hours. Actual run-time will vary depending on ambient temperature and alarm conditions. The runtime of the device at -20 °C [-4 °F] will be approximately 14 hours.

The alarm levels for the individual gases are factory-set and can be changed through the Setup Menu.

A Low Battery Warning indicates that a nominal 30 minutes of operation remain before the battery's charge is depleted.



The duration of remaining device operation during a Low Battery Warning depends on ambient temperatures.

When the device goes into Low Battery Warning, the:

- battery life indicator flashes
- alarm sounds
- alarm LEDs flash
- display shows "Low Batt" and

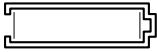

- device repeats this warning every 15 seconds and continues to operate until it is turned off or battery shutdown occurs.

Battery Shut Down



Attention!

If battery shutdown alarm activates, stop using the device as it no longer has enough power to indicate potential hazards, and persons relying on this product for their safety could sustain serious personal injury or death.

The device goes into battery shutdown mode 60 seconds before final shutdown [when the batteries can no longer operate the device]:

- On the display flashes "Low Batt" and



- Alarm sounds and lights flash; alarm cannot be silenced,
- No other pages can be viewed; after approximately one minute, the device automatically turns off.

When battery shutdown condition occurs:

- (1) Leave the area immediately.
- (2) Recharge the battery.

Battery Charging



Warning!

Risk of explosion: Do not recharge device in hazardous area.



Attention!

Use of any charger, other than the charger supplied with the device, may damage or improperly charge the batteries.

The charger is capable of charging a completely depleted pack in less than four hours in normal, room-temperature environments.



Allow very hot or cold devices to stabilise for one hour at room temperature before attempting to charge.

- Minimum and maximum ambient temperature to charge the device is 10 °C [50 °F] and 35 °C [95 °F], respectively.
- For best results, charge the device at room temperature [23 °C].

To Charge the Device

- Firmly insert the device into the charging cradle.
- The battery symbol will scroll through a progressively increasing number of segments and the charge LED will be red until 90 % of full charge has been obtained. Then the battery symbol will remain fully illuminated and the charge LED will be green while the battery is trickle charged to its full capacity.
- If a problem is detected during charging, the battery symbol will flash and the charge LED will be orange. Remove, then replace the device in the charging cradle to reset the charge cycle.

2.5 Viewing Optional Displays

The Main Screen appears at device turn-on.

Optional displays can be viewed by pressing the ▼ button to move to:

Bump Mode

- (1) To select the Bump mode, press the **ON/OFF** button.
- (2) To move forward, press the ▼ button.
- (3) To move backward to the Main page, press the ▲ button.

Peak Readings [PEAK page]

The peak icon [→ chapter 2.3] shows the highest levels of gas recorded by the device since turn-on or since peak readings were reset.

To reset the peak readings:

- (1) Access the PEAK page.
- (2) Press the ▲ button.

Minimum Readings [MIN page]

This page shows the lowest level of oxygen recorded by the device since turn-on or since the MIN reading was reset.

The minimum icon [→ chapter 2.3] appears on the display.

To reset the MIN reading:

- (1) Access the MIN page.
- (2) Press the ▲ button.

Short Term Exposure Limits [STEL page]**Attention!**

If the STEL alarm activates, leave the contaminated area immediately; the ambient gas concentration has reached the preset STEL alarm level. Failure to follow this warning will cause over-exposure to toxic gases and persons relying on this product for their safety could sustain serious personal injury or death.

The STEL icon [→ chapter 2.3] appears on the display to show the average exposure over a 15 minute period.

When the amount of gas detected by the device is greater than the STEL limit:

- Alarm sounds
- Alarm LEDs flash
- STEL icon flashes.

To reset the STEL:

- (1) Access the STEL page.
- (2) Press the ▲ button.

The STEL alarm is calculated over a 15 minute exposure.

STEL calculation examples:

Assume the device has been running for at least 15 minutes:

15 minute exposure of 35 ppm:

$$\frac{[15 \text{ minutes} \times 35 \text{ ppm}]}{15 \text{ minutes}} = 35 \text{ ppm}$$

10 minute exposure of 35 ppm and 5 minutes exposure of 5 ppm:

$$\frac{[10 \text{ minutes} \times 35 \text{ ppm}] + [5 \text{ minutes} \times 5 \text{ ppm}]}{15 \text{ minutes}} = 25 \text{ ppm}$$

Time Weighted Average [TWA page]



Attention!

If the TWA alarm activates, leave the contaminated area immediately; the ambient gas concentration has reached the preset TWA alarm level. Failure to follow this warning will cause over-exposure to toxic gases and persons relying on this product for their safety could sustain serious personal injury or death.

The TWA icon [→ chapter 2.3] appears on the display to show the average exposure since the device was turned on or since the TWA reading was reset. When the amount of gas detected is greater than the eight-hour TWA limit:

- Alarm sounds
- Alarm LEDs flash
- TWA icon flashes.

To reset the TWA:

- (1) Access the TWA page.
- (2) Press the ▲ button.

The TWA alarm is calculated over an eight-hour exposure.

TWA calculation examples:

1 hour exposure of 50 ppm:

$$\frac{[1 \text{ hour} \times 50 \text{ ppm}] + [7 \text{ hours} \times 0 \text{ ppm}]}{8 \text{ hours}} = 6.25 \text{ ppm}$$

4 hour exposure of 50 ppm and 4 hour exposure of 100 ppm:

$$\frac{[4 \text{ hours} \times 50 \text{ ppm}] + [4 \text{ hours} \times 100 \text{ ppm}]}{8 \text{ hours}} = 75 \text{ ppm}$$

12 hour exposure of 100 ppm:

$$\frac{[12 \text{ hours} \times 100 \text{ ppm}]}{8 \text{ hours}} = 150 \text{ ppm}$$

Time Display

Current time appears on the display in a 12 hour format by default.

A 24-hour format can be selected using MSA Link.

Date Display

Current date appears on the display in the format: **MMM-DD-YYYY**.

Last cal page

Displays the device last successful calibration date in the format:

MMM-DD-YYYY

Cal due page

Displays the days until the device's next calibration is due [user selectable].

Motion Alert Activation

To activate or deactivate the Motion Alert feature, press the ▲ button while the Motion Alert Activation page is displayed. When the Motion Alert feature is active, the Motion Alert symbol [→ chapter 2.3] will flash every 3 seconds. The device will enter pre-alarm when no motion is detected for 20 seconds. This condition can be cleared by moving the device.

After 30 seconds of inactivity, the full Motion Alert alarm is triggered. This alarm can only be cleared by pressing the ▲ button.

2.6 Sensor Missing Alarm

The device enters the Sensor Missing alarm if the instrument detects that an enabled O₂ or Combustible sensor is not properly installed in the instrument or is not functional.

For the O₂ sensor, the sensor missing feature is checked when the instrument is turned on and when leaving the Setup Mode.

The combustible Sensor Missing feature is continuously monitored.

If a sensor is detected as missing, the following occurs:

- "SENSOR ERROR" displays
- The flag above the sensor detected as missing flashes on the display
- Alarm sounds and lights flash.
- Yellow Fault LED is on solid.
- If there is a sensor error at startup, the device shuts off in 60 seconds.

2.7 Sensor End of Life Warning

If a sensor is nearing its end of life, the device will warn the user following a sensor calibration. The sensor is still fully functional at this point, but the warning gives the user time to plan for a replacement sensor and minimise downtime. The ♥ symbol will be continuously displayed. For more details see chapter 3.9.

2.8 Sensor End of Life Indicator

If the device cannot calibrate one or more sensors, the device will display "SPAN ERR" followed by the Alarm symbol and ♥ symbol to indicate end of sensor life. For more details see chapter 3.9.

2.9 Monitoring Toxic Gases

The device can monitor the concentration of the following toxic gases in ambient air:

- Carbon Monoxide [CO]
- Hydrogen Sulphide [H₂S]

The device displays the gas concentration in parts per million [PPM] or mg/m³ on the Measuring page until another page is selected or the device is turned off.

**Attention!**

If an alarm is triggered while using the device, leave the area immediately.

Remaining on site under such circumstances can cause serious personal injury or death.

The device has four gas alarms:

- HIGH Alarm
- LOW Alarm
- STEL Alarm
- TWA Alarm

If the gas concentration reaches or exceeds the alarm set point, the device:

- backlight turns on
- provides a vibrating alarm
- displays and flashes the Alarm symbol and either the Minimum icon [LOW alarm] or the Maximum [PEAK] icon [HIGH alarm]
- enters an alarm state.

2.10 Monitoring the Oxygen Concentration

The device monitors the oxygen concentration in ambient air. The alarm set points can be set to activate on two different conditions:

- Enriched - oxygen concentration > 20.8 % or
- Deficient - oxygen concentration < 19.5 %.



While the device can detect up to 30 % oxygen in ambient air, it is approved for use only up to 21 % oxygen.



Attention!

If an alarm is triggered while using the device, leave the area immediately.

Remaining on site under such circumstances can cause serious personal injury or death.

When the alarm set point is reached for either of the above conditions:

- an alarm sounds
- alarm LEDs flash
- a vibrating alarm triggers
- device displays and flashes the Alarm icon and either the Minimum icon [Enriched alarm] or the Maximum icon [Deficient alarm] [→ chapter 2.3] along with the corresponding oxygen concentration.



The LOW alarm [oxygen deficient] is latching and will not automatically reset when the O₂ concentration rises above the LOW set point. To reset the alarm press the ▲ button. If the alarm condition still exists, the ▲ button only silences the alarm for five seconds.

False oxygen alarms can occur due to changes in barometric pressure [altitude] or extreme changes in ambient temperature.

It is recommended that an oxygen calibration be performed at the temperature and pressure of use. Be sure that the device is in known fresh air before performing a calibration.

2.11 Monitoring Combustible Gases

The device can monitor these concentrations in ambient air:

- Methane
- Combustible gases

The device displays the gas concentration in % LEL or % CH₄ on the Measuring page until another page is selected or the device is turned off.



Attention!

If an alarm is triggered while using the device, leave the area immediately.

Remaining on site under such circumstances can cause serious personal injury or death.

The device has two alarm set points:

- HIGH Alarm
- LOW Alarm

If the gas concentration reaches or exceeds the alarm set point, the device:

- backlight turns on
- a vibrating alarm triggers
- displays and flashes the Alarm symbol and either the Minimum icon [LOW alarm] or the Maximum [PEAK] icon [HIGH alarm]
- enters an alarm state.



When gas reading exceeds 100% LEL CH₄, the device enters a Lock Alarm state, the combustible sensor shuts down and displays “xxx” in place of the actual reading. This state can only be reset by turning the device off and on in a fresh air environment.

**Attention!**

A combustible gas reading of “100” indicates the atmosphere is above 100% LEL CH₄ and an explosion hazard exists. Move away from contaminated area immediately.

In such cases, the device LockAlarm feature activates.



Check your national standard values for 100% LEL. Some countries use 5% vol and some use 4.4% vol as 100% LEL CH₄.

3 Operation

3.1 Environmental Factors

A number of environmental factors may affect the gas sensor readings, including changes in pressure, humidity and temperature. Pressure and humidity changes affect the amount of oxygen actually present in the atmosphere.

Pressure Changes

If pressure changes rapidly [e.g., stepping through airlock], the oxygen sensor reading may temporarily shift and possibly cause the detector to alarm. While the percentage of oxygen may remain at or near 20.8 vol%, the total amount of oxygen present in the atmosphere available for respiration may become a hazard if the overall pressure is reduced by a significant degree.

Humidity Changes

If humidity changes by any significant degree [e.g., going from a dry, air conditioned environment to outdoor, moisture laden air], oxygen readings can be reduced by up to 0.5%, due to water vapour in the air displacing oxygen.

The oxygen sensor has a special filter to reduce the effects of humidity changes on oxygen readings. This effect will not be noticed immediately, but slowly impacts oxygen readings over several hours.

Temperature Changes

The sensors have built-in temperature compensation. However, if temperature shifts dramatically, the sensor reading may shift. Zero the device at the work site temperature for the least effect.

3.2 Turning on the Device

For more information, see the flow charts in [→ chapter 7].

- Turn the device on with the **ON/OFF** button.

The device performs a self test and then goes to Fresh Air Setup:

- all display segments are activated
- audible alarm sounds
- alarm LEDs light
- vibrating alarm is activated.

During the self test, the device checks for missing sensors. In the case of a missing sensor, the device displays the Sensor Missing screen and alarms until it is turned off. Otherwise, the turn-on sequence continues.

The device displays:

- Alarm & display self test
- Manufacturer name
- Device name
- Software version
- Sensor discovery
- Combustible gas type
- Toxic gas units
- Alarm set points [PEAK, MIN] [STEL, TWA]
- Calibration values
- Date and time display
- Last cal date [if activated]
- CAL due date [if activated]
- Fresh Air Setup option.

Screen Displays during Startup



During the startup sequence, all automatic page display timeouts are preset to a range from two to four seconds.

Several sequences and screens occur during start up:

Device Self Test

The device performs a self test.

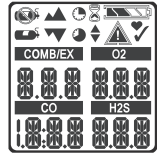

Device Name and Software version

Software version and device name display.



Combustible Gas Type

Name of Combustible Gas Type displays, e.g. BUTANE.

NOTE: Combustible gas type can be changed manually through the SENSOR SETUP menu or the MSA Link software.



Toxic Gas Units

Name of Toxic Gas Units displays [ppm or mg/m³].

NOTE: Toxic units can only be modified through the MSA Link software.



Alarm Set points

Alarm set points for all installed and activated sensors display.

LOW alarm set points display, followed by HIGH alarm set points.

NOTE: Alarm set points can be changed manually through the Setup menu or the MSA Link software.

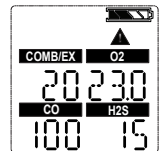
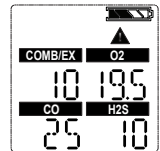

STEL and TWA Set points

The preset STEL and TWA values for installed and activated sensors display.

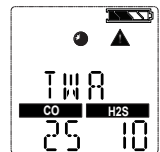
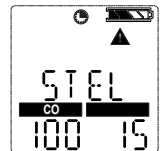

Calibration Values

The preset STEL and TWA values for installed and activated sensors display.

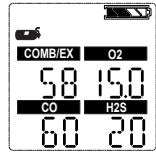

Time and Date

The date displays in a month, day and year format.

NOTE: In the event that the battery is fully discharged, the time and date reset. At startup, the user is prompted to enter the time and date.

If the time and date information is missing, they are reset to [Jan-01-2008] with time stamp [00:00].



Last CAL Date and CAL Due

NOTE: These display options can be set by MSA Link software. If these options are not set, these screens are not displayed.

- By default Last Cal is activated.
- By default Cal Due is deactivated.



Fresh Air Setup [FAS]

The FAS screen is prompted.



Fresh Air Setup [FAS]

The FAS is for automatic Zero calibration of the device.

The Fresh Air Setup has limits. The zero of any sensor that is outside of these limits will not be adjusted by the FAS command.



Warning!

Do not activate the Fresh Air Setup unless you are certain you are in fresh, uncontaminated air; otherwise, inaccurate readings can occur which can falsely indicate that a hazardous atmosphere is safe. If you have any doubts as to the quality of the surrounding air, do not use the Fresh Air Setup feature. Do not use the Fresh Air Setup as a substitute for daily calibration checks. The calibration check is required to verify span accuracy. Failure to follow this warning can result in serious personal injury or death.



If a battery charging cycle is interrupted before it is completed [4 hours for a fully discharged battery], allow the device's internal temperature to stabilize for 30 minutes before performing a Fresh Air Setup.

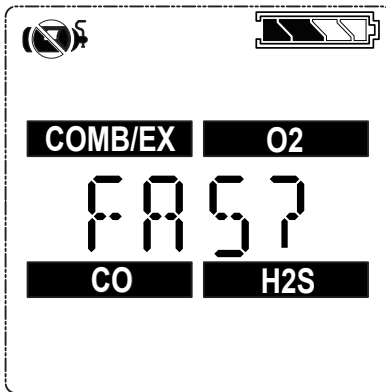

Fig. 3 Fresh Air Setup

If this option is enabled, the device displays "FAS?", prompting the user to perform a Fresh Air Setup.

- (3) Press the ▲ button to bypass the Fresh Air Setup.
 - ▷ The Fresh Air Setup is skipped and the device goes to the Measuring page [Main page].
- (4) Press the **ON/OFF** button within 10 seconds to perform the Fresh Air Setup.
 - ▷ The device starts the FAS.
 - ▷ The screen shows a No Gas Symbol, a blinking hourglass, and all enabled gas sensor readings.
 - ▷ At the end of the FAS Calibration, the device displays "FAS OK" or "FAS ERR". along with the flags of the sensors that were outside of the FAS limits. All sensors that are within the FAS limits will be zeroed.

3.3 Measurement Mode [Normal Operation]

In Normal Operation mode, the user can check the Minimum and Peak readings prior to clearing the STEL and TWA values or performing a Span and Zero Calibration. The following options pages can be executed from the Normal Operation screen:

Bump Page

This page allows the user to perform a bump check.

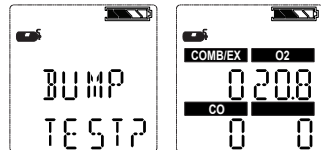

Peak Page

This page shows the peak readings for all sensors.

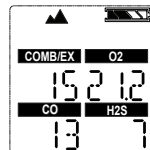

Min Page

This page shows the minimum reading for the oxygen sensor.

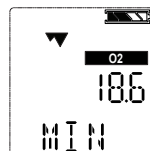

STEL Page

This page shows the calculated STEL readings of the device.

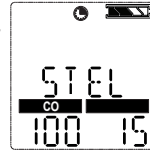
**TWA Page**

This page shows the calculated TWA readings of the device.

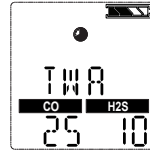
**Time / Date Page**

This page shows actual time and date settings of the device.

**Motion Alert [optional]**

This page allows the Motion Alert Feature to be activated or deactivated.

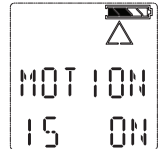
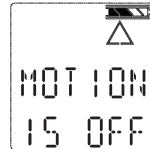

Using the three device buttons, the user can navigate through each sub-menu in a top/down sequence.

Refer to chapter 2.5 and in the appendix for detailed instructions on navigating through these screens.

3.4 Device Setup

The setup menus can be accessed only when the device is turned on while pressing and holding the ▲ button.

This mode can only be activated at device turn-on.

The operation is as follows:

- (1) Press and hold the ▲ button while turning the device on.
 - Use the ▲ and ▼ buttons to enter the setup password.
The default password is "672".
- (2) Press **ON/OFF** button to enter the setup menus.
 - Incorrect password: device enters the Measure mode.
 - Correct password: device continues/beeps three times.



The password can be changed through the MSA Link software.

In the Setup mode:

- Press the **ON/OFF** button to store chosen value or go to the next page.
- Press ▲ button to increase values by one or toggle a selection on or off.
- Press and hold ▲ button to increase values by 10.
- Press ▼ button to decrease values by one or toggle a selection on or off.
- Press and hold ▼ button to decrease values by 10.

The following options are available by pressing the ▼ and ▲ buttons:

- Sensor Setup [SENSOR SETUP]
- Calibration Setup [CAL SETUP]
- Alarm Setup [ALARM SETUP]
- Setup Time and Date [TIME SET]
- EXIT

Sensor Setup

Each sensor can be turned on or off.

For more information, see the flow charts in [→ chapter 2.3].

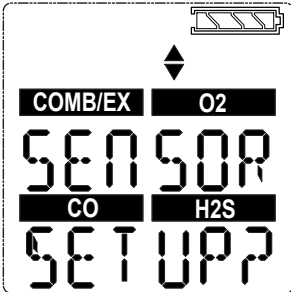

Fig. 4 Sensor Setup

- (1) To bypass this setup, press the ▼ or ▲ button; otherwise, continue as follows.
- (2) Press the **ON/OFF** button to enter the submenu.
- (3) Use the ▼ or ▲ button to change the option and confirm with the **ON/OFF** button.
- (4) Repeat this procedure for all other sensors.
- (5) After setting the last sensor, continue to Calibration Setup.

Calibration Setup

The user can change and set the calibration values for each sensor.

It is also possible to select whether the Cal Due screen is displayed and set the number of days until the next calibration is due.

For more information, see the flow charts in [→ chapter 2.3].

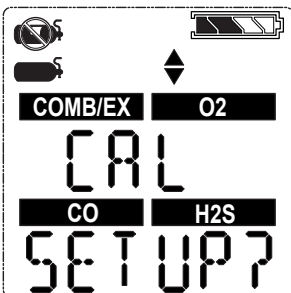

Fig. 5 Calibration Setup

- (1) To bypass this setup, press the ▼ or ▲ button; otherwise, continue as follows.
- (2) Press the **ON/OFF** button to enter the submenu.
 - ▷ The calibration gas concentration of the first sensor is shown.
- (3) Press the ▼ or ▲ button to change the value.
- (4) Press the **ON/OFF** button to store the value.
 - ▷ Setup screen for the next sensor is displayed.
- (5) Repeat the procedure for all other sensors.
 - ▷ After setting the last sensor, the user is prompted to set CALDUE.
- (6) Press the ▼ or ▲ button to enable or disable CALDUE.

Press the **ON/OFF** button to confirm the selection.
- (7) If CALDUE is set on, press the ▼ or ▲ button to select the number of days
- (8) Confirm with the **ON/OFF** button.
- (9) After confirmation, continue to Alarm setup.

Alarm Setup

The user can switch all alarms on or off and change the alarm set points for each sensor.

For more information, see the flow charts in [→ chapter 2.3].

See chapter 2.3 for alarm adjustment limits. The value of the High Alarm can only be set to a value that is higher than the Low Alarm set point.

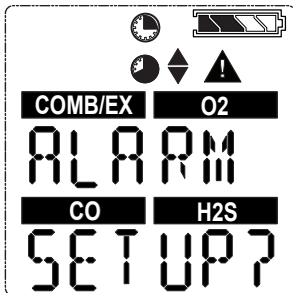

Fig. 6 Alarm Setup

- (1) To bypass this setup, press the ▼ or ▲ button; otherwise, continue as follows.
- (2) Press the **ON/OFF** button to enter the submenu.
 - ▷ The calibration gas concentration of the first sensor is shown.
- (3) Set alarms on or off by pressing the ▼ or ▲ button.
- (4) Press the ▼ or ▲ button to change the value.

- (5) Press the **ON/OFF** button to store the value.
 - ▷ HIGH ALARM settings for the first sensor display.
- (6) Press the ▼ or ▲ button to change the value.
- (7) Press the **ON/OFF** button to store the value.
 - ▷ STEL ALARM settings [for toxic sensors only] display.
- (8) Press the ▼ or ▲ button to change the value.
- (9) Press the **ON/OFF** button to store the value.
 - ▷ TWA ALARM settings [for toxic sensor only] for display.
- (10) Press the ▼ or ▲ button to change the value.
- (11) Press the **ON/OFF** button to store the value.
- (12) Repeat the procedure for all other sensors.
- (13) After setting the last sensor, continue to Time and Date setup.
60% L.E.L. or 3.0% volume of methane is the maximum High Alarm set point that can be programmed.

The combustible alarm can be turned off in the device setup.

When the combustible alarm is turned off, this is only indicated during startup of the device: a startup screen will indicate that the combustible alarm is turned off. When turned on, the combustible high alarm is latching.

The combustible alarm can be silenced momentarily by pressing the ▲ button. However, if the gas concentration causing the alarm is still present, the device will go back into alarm.

Setup Time and Date

This submenu is for setting date and time.

For more information, see the flow charts in [→ chapter 2.3].

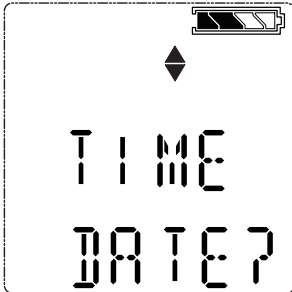

Fig. 7 Date and Time Setup

- (1) To bypass this setup, press the ▼ or ▲ button; otherwise, continue as follows.
- (2) Press the **ON/OFF** button to enter the submenu.
- (3) Set month by pressing the ▼ or ▲ button.
- (4) Press the **ON/OFF** button to confirm month.
- (5) Repeat this procedure for day, year, hours and minutes.
 - ▷ By default, time is displayed in 12 hour format.
 - ▷ The **EXIT** screen will be displayed next.
- (6) Confirming this screen with the **ON/OFF** button exits the device setup.
 - ▷ If the sensors have not warmed up yet, the countdown is displayed.
 - ▷ The device then goes to Measuring mode.

3.5 Data Logging

Connecting device to PC

- (1) Switch on the device and align the Datalink Communication port on the device to the IR interface of the PC.
- (2) Use the MSA Link software to communicate with the device.
See MSA Link documentation for detailed instructions.

3.6 Function Tests

Alarm Test

- Turn on the device. Verify that:
 - all LCD segments are activated momentarily
 - alarm LEDs flash
 - horn sounds briefly
 - vibrating alarm triggers briefly.

3.7 Safe LED

The device is equipped with a green Safe LED. This green Safe LED flashes every 15 seconds under the following conditions:

- the SAFE LED feature is enabled
- device is in Measurement Mode [Normal Operation]
- combustible reading is 0% LEL or 0.00% CH₄
- Oxygen [O₂] reading is 20.8%
- Carbon Monoxide [CO] reading is 0 ppm or mg/m³
- Hydrogen Sulphide [H₂S] reading is 0 ppm or 0 mg/m³
- no gas alarms are present [low or high]
- device is not in Low Battery warning or alarm
- CO, H₂S, STEL and TWA readings are 0 ppm or 0 mg/m³.

3.8 Bump Test



Attention!

Perform a Bump Test before each day's use to verify proper device operation. Failure to perform this test can result in serious personal injury or death.

This test quickly confirms that the gas sensors are functioning. Perform a full calibration periodically to ensure accuracy and immediately if the device fails the Bump Test. The Bump Test can be performed using the procedure below or automatically using the GALAXY Test Stand.

It is required that the device's sensitivity be tested before each day's use on a known concentration of methane equivalent to 25 - 50% of full scale concentration. Accuracy must be within 0 to +20% of actual. Correct accuracy by performing the calibration procedure within this manual.

Equipment

See accessory section for ordering information for these components.

- Calibration Check Gas Cylinder
- 0.25 liters/min. Flow Regulator
- 1/8" ID Superthane Ester Tubing
- Calibration Cap

Performing a Bump Test

- (1) From the normal measure screen press the ▼ button to display "BUMP TEST?".
- (2) Verify the gas concentrations displayed match the Calibration Check Gas Cylinder. If they do not, adjust the values through the Calibration Setup menu.

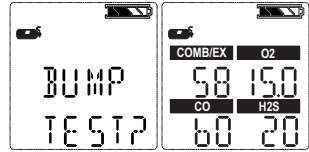

- (3) Attach the calibration cap to the device.
 - ▷ Insert tab on calibration cap into slot on device.
 - ▷ Press calibration cap as shown until it seats onto device.
 - ▷ Press both side tabs down onto device until they snap in.
 - ▷ Ensure that the calibration cap is properly seated.
 - ▷ Connect one end of the tubing to the calibration cap.
 - ▷ Connect other end of tubing to the cylinder regulator [supplied in the calibration kit].

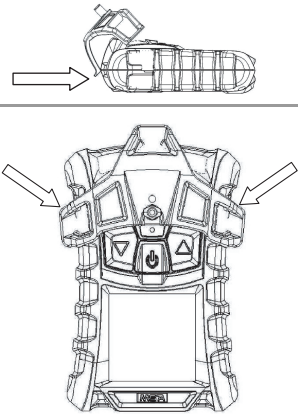

- (4) Press the **ON/OFF** button to start the bump test then open the valve on the regulator. The hour-glass will flash and the sensors will respond to the gas.

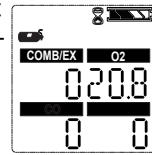

After the Bump Test completes, the device momentarily displays "BUMP PASS" or "BUMP ERROR" along with the label of any sensor that failed before returning to Measure mode. If the device fails the Bump Test, perform a calibration as described in chapter 3.9.

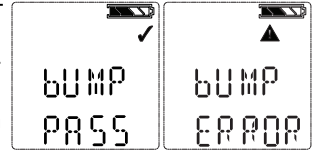

The ✓ symbol will be displayed in the Measure mode for 24 hours after a successful Bump Test.

3.9 Calibration

The device can be calibrated either manually using this procedure or automatically using the GALAXY Test Stand.

Calibration must be performed using a flow regulator with a flow rate set to 0.25 litres per minute.

If a battery charging cycle is interrupted before it is completed [4 hours for a fully discharged battery], allow the device's internal temperature to stabilise for 30 minutes before performing a Calibration.



Under normal circumstances MSA recommends calibration at least every six months, however, many European countries have their own guidelines. Please check your national legislation.

Fresh Air Setup and Zero Calibration



To skip the Zero procedure and move directly to the Calibration Span procedure, push the ▲ button. If no button is pushed for 30 seconds, the device prompts user to perform a Span calibration before returning to the Normal Operation mode.

- (1) Press and hold the ▲ button in Normal Operation mode for three seconds.
- (2) If calibration lockout option is selected, enter password.
 - ▷ ZERO screen is then displayed.

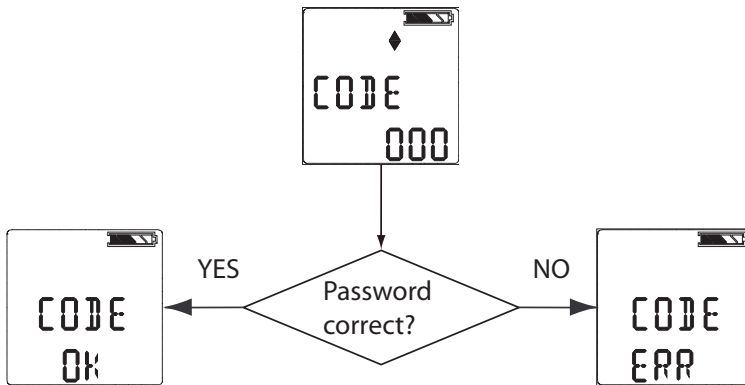

- If calibration lockout option is NOT selected:

▷ ZERO screen displays.

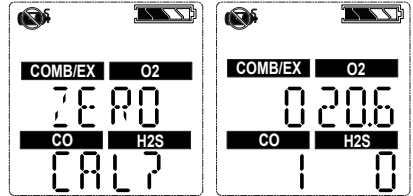

- (3) With the device exposed to fresh air, press the **ON/OFF** button to confirm the ZERO screen. A sensor refresh and Zero Calibration will occur.



Alternatively press the ▲ button to execute a Fresh Air setup [FAS]. See chapter 3.2 for more details.

After Zero calibration completes, the device momentarily displays “ZERO PASS” or “ZERO ERR” along with the flag of any sensor that failed.

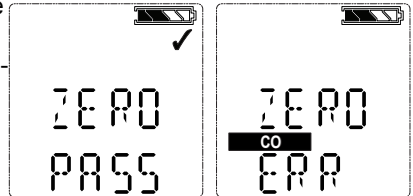

Span Calibration



To skip the Span procedure, push the ▲ button.

If no button is pushed for 30 seconds, the device returns to the Measuring mode.

- (1) Once the Zero is set, the *SPAN* screen displays.
- (2) Connect the appropriate calibration gas to the device.
- (3) Attach the calibration cap to the device.

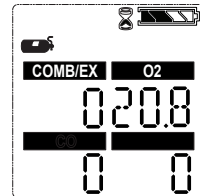
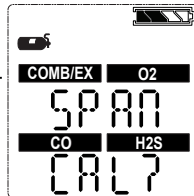

- ▷ Insert tab on calibration cap into slot on device.
 - ▷ Press calibration cap as shown until it seats onto device.
 - ▷ Press both side tabs down onto device until they snap in to.
 - ▷ Ensure that the calibration cap is properly seated.
 - ▷ Connect one end of the tubing to the calibration cap.
 - ▷ Connect other end of tubing to the cylinder regulator [supplied in the calibration kit].
- (4) Open the valve on the regulator.
- (5) Press the **ON/OFF** button to calibrate [span] the device.
 - ▷ LEDs flash
 - ▷ *SPAN* calibration starts.

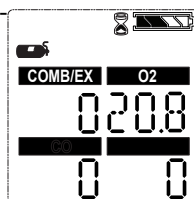
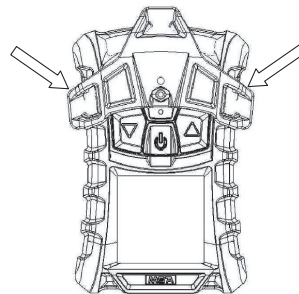
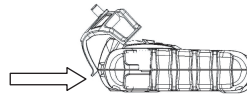

- After the SPAN calibration completes, the device momentarily displays "SPAN PASS" or "SPAN ERR" along with the label of any sensor that failed then returns to the Measuring mode.

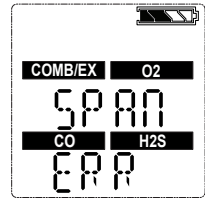
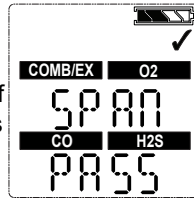

If a sensor is nearing its end of life, this "SPAN PASS" indication will be followed by the end of sensor life warning [♥ symbol]. The ♥ symbol, along with the gas type of the sensor nearing its end of life, will blink for 15 seconds when the device returns to measure mode. When in measure mode, the ♥ symbol is continuously displayed.

Finishing Calibration

- (1) Close the valve on the regulator.
- (2) Remove the calibration cap.

The calibration procedure adjusts the span value for any sensor that passes the calibration test; sensors that fail calibration are left unchanged. Since residual gas may be present, the device may briefly go into an exposure alarm after the calibration sequence is completed.

Autocalibration Failure

If the span calibration is unsuccessful:

- A sensor life indicator is displayed [Alarm symbol and ♥ symbol] to show the sensor has reached its end of life and should be replaced.
- The device will remain in alarm state until the ▲ button is pressed.
- The Alarm symbol and ♥ symbol will remain on the display until a successful calibration or sensor in question is replaced.



A span calibration can fail for many reasons besides sensor at the end of his life. If a span calibration failure occurs, items such as remaining gas in the calibration cylinder, gas expiration date, security of the calibration cap, etc. should be verified and calibration should be repeated prior to replacing the sensor.

4 Maintenance

If an error occurs during operation, use the displayed error codes to determine appropriate next steps.







The MSA warranty for sensors, rechargeable batteries, housing and electronics is only valid if the device is annually maintained by the manufacturer or an authorized person in accordance with the operating manual.

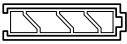

Refer to EN 50073 [Guide for the selection, installation, use and maintenance of apparatus for the detection and measurement of combustible gases or oxygen].

4.1 Troubleshooting

Problem	Description	Reaction
ERROR TEMP	Temperature is below -40°C or above 75°C.	Return device to normal temperature range and recalibrate. Contact MSA
ERROR EE	EEPROM Memory error	Contact MSA
ERROR PRG	Flash Memory error	Contact MSA
ERROR RAM	RAM Memory error	Contact MSA
ERROR UNK	Unknown error	Contact MSA
 LOW BATT	Battery warning repeats every 15 seconds.	Remove from service as soon as possible and recharge battery
 BATT ALARM	Battery is completely discharged.	Device is no longer sensing gas. Remove from service and recharge battery.
ERROR CHARGE	Charge error	Device must be between 10° C and 36° C to charge. Contact MSA if problem persists
SENSOR ERROR	Missing Sensor	Verify if sensor is properly installed
Device does not turn on	Low battery	Charge device
	Sensor warning	Sensor is near the end of its life
 & 	Sensor alarm	Sensor has reached the end of its life and cannot be calibrated. Replace sensor and recalibrate.

4.2 Live Maintenance Procedure - Replacing and Adding a Sensor



Warning!

Remove and reinstall sensors carefully, ensuring that the components are not damaged; otherwise device intrinsic safety may be adversely affected, wrong readings could occur, and persons relying on this product for their safety could sustain serious personal injury or death.



Attention!

Before handling the PC board, ensure you are properly grounded; otherwise, static charges from your body could damage the electronics. Such damage is not covered by the warranty. Grounding straps and kits are available from electronics suppliers.

To add a sensor to an device that is not already equipped with a full array of sensors, remove the sensor plug from in front of the formerly unused sensor housing.



While device case is open, do not touch any internal components with metallic/conductive objects or tools.

Damage to the device can occur.

- (1) Verify that the device is turned off.
- (2) Remove the four case screws, and remove the case front while carefully noting the orientation of the sensor gasket.
- (3) Gently lift out and properly discard the sensor to be replaced.
 - ▷ Using fingers only, gently remove the toxic, combustible, or oxygen sensor by gently rocking it while pulling it straight from its socket.
- (4) Carefully align the new sensor contact pins with the sockets on the printed circuit board and pressing it firmly in place.
 - ▷ Insert the toxic sensor by placing it in the left-hand position of the sensor holder.
 - ▷ Insert the O₂ sensor by placing it in the right-hand position of the sensor holder.
 - ▷ Insert the combustible sensor by placing it in the middle position of the sensor holder.
- (5) Ensure groove in combustible sensor aligns with tab at top of holder.
 - ▷ If any sensor is not to be installed, ensure that a sensor plug is installed properly in its place.

- (6) If replacing sensor filters at this time:
 - ▷ Carefully peel off old filters taking care not to damage the inside of the case.
 - ▷ On new filters peel off backing exposing adhesive. Note proper orientation of each filter and apply to inside of front case adhesive side against case.
 - ▷ Press filter into place taking care not to damage filter surface.
- (7) Reinstall the sensor gasket in the case front.
- (8) Ensure sensor gasket is properly installed.
- (9) Re-install the screws.
- (10) Turn on the device.

<p>If the sensor replaced is the same as the previous sensor:</p>	<p>If the sensor replaced is not the same as the previous sensor or this sensor channel was deactivated:</p>
<ul style="list-style-type: none"> - The device starts up normally. - The device automatically senses that a new sensor is installed and displays the "SENSOR DSCVRY" screen. 	<ul style="list-style-type: none"> - The device automatically senses the difference and displays "SENSOR CHANGE". - "ACCEPT?" appears on the display.
	<ul style="list-style-type: none"> ▷ Accept the change with ▼ button or reject with ▲ button. ▷ Go into the sensor setup and turn on the appropriate sensor [→ chapter 3.4].

- (11) Calibrate the device after the sensors have stabilised.



Danger!

Calibration is required after a sensor is installed; otherwise, the device will not perform as expected and persons relying on this product for their safety could sustain serious personal injury or death.



Allow sensors to stabilise at room temperature for at least 30 minutes before calibration [→ chapter 3.9].

4.3 Cleaning

Clean the exterior of the device regularly using only a damp cloth. Do not use cleaning agents as many contain silicones which will damage the combustible sensor.

4.4 Storage

When not in use, store the device in a safe, dry place between 18 °C and 30 °C [65 °F and 86 °F]. After storage, always recheck device calibration before use.

4.5 Scope of Delivery

Pack the device in its original shipping container with suitable padding. If the original container is unavailable, an equivalent container may be substituted.

5 Technical Specifications/Certifications

5.1 Technical Specifications

Weight	224 g [device with battery and clip]
Dimensions [L x W x H]	112 x 76 x 33 mm – without fastening clip
Alarms	Four gas alarm LEDs, a charge status LED, an audible alarm and a vibrating alarm
Volume of audible alarm	95 dBA at 30 cm typical
Display	LCD display
Battery type	Rechargeable Li polymer battery. Li polymer battery must not be charged in Ex area.
Device run time	24 hours at 25 °C [77 °F]
Charging time	≥ 4 hours The maximum safe area charging voltage $U_m = 6.7$ VDC
Warm up time	2 min
Temperature range	-10 °C to 50 °C [14 °F to 122 °F] Normal operating range -20 °C to 50 °C [-4 °F to 122 °F] Extended operating range 10 °C to 35 °C [50 °F to 95 °F] while charging battery
Humidity range	15 % – 90 % relative humidity, non-condensing, 5 % – 95 % RH intermittent
Atmospheric pressure range	800 to 1200 mbar
Ingress protection	IP 67
Measuring methods	Combustible gases: Catalytic sensor Oxygen: Electrochemical sensor Toxic gases: Electrochemical sensor

	Combustible	O ₂	CO	H ₂ S
Measuring range	0-100% LEL	O ₂ 0-30% Vol.	0-999 mg/m ³	0-200 ppm
	0-5.00% CH ₄	CO 0-1999% Vol.		[0-284 mg/m ³]



The ppm to mg/m³ conversion is calculated at 20° C and at atmospheric pressure.

5.2 Factory-set Alarm thresholds

Sensor	LOW alarm	HIGH alarm	STEL	TWA
LEL	10 % LEL	20 % LEL	--	--
O ₂	19.5 %	23.0 %	--	--
CO	25 ppm [29 mg/m ³]	100 ppm [116 mg/m ³]	100 ppm [116 mg/m ³]	25 ppm [29 mg/m ³]
H ₂ S	10 ppm [14.2 mg/m ³]	15 ppm [21.3 mg/m ³]	15 ppm [21.3 mg/m ³]	10 ppm [14.2 mg/m ³]

Sensor	Min. alarm set point	Max. alarm set po	Auto-cal values
LEL	5	60	58%
O ₂	5.0	29	15.0%
CO	15 ppm [23.2 mg/m ³]	1700 ppm [999mg/m ³]	60 ppm [69.9 mg/m ³]
H ₂ S	5 ppm [7.1 mg/m ³]	175 ppm [205.9 mg/m ³]	20 ppm [28.4mg/m ³]



While the device can detect up to 25 % oxygen in ambient air, it is approved for use only up to 21 % oxygen.

5.3 Certification

See device label for the approvals that apply to your specific device.

USA and Canada

USA



See device label for the approvals that apply to your specific device.

Canada



See device label for the approvals that apply to your specific device.

Europe Union

The product ALTAIR 4X complies with the following directives, standards or standardized documents:

Directive 94/9/EC [ATEX]:	II 1G Ex ia IIC T4, -40°C to +60°C, IP67 [Zone 0 with no combustible sensor installed] II 2G Ex ia d IIC T4, -40°C to +60°C, IP67 [Zone 1 with combustible sensor installed] CE 0080
Directive 2004/108/EEC [EMC]:	EN50270 Type 2, EN61000-6-3

Other Countries

Australia/New Zealand	TestSafe Australia Ex ia s IIC T4, -40°C to +60°C, IP67 [Zone 0]
IECEX	TestSafe Australia Ex ia IIC T4, -40°C to +60°C, [Zone 0 with no combustible sensor installed] Ex ia d IIC T4, -40°C to +60°C, [Zone 1 with combustible sensor installed]

European Community

The product ALTAIR 4 complies with the following directives, standards or standardised documents:

Manufacturer: Mine Safety Appliances Company
1000 Cranberry Woods Drive
Cranberry Township, PA 16066 USA

Product: **ALTAIR 4X**

Type of protection: EN 60079-0: 2006, EN 60079-1: 2004, EN 60079-11: 2007

Marking:  III 2G Ex ia d IIC T4
-20 °C ≤ Ta ≤ +50 °C
Um 6,7 V

EC-Type Examination Certificate: FTZU 07 ATEX 0169 X

Quality Assurance Notification: 0080

Year of Manufacture: see Label
Serial Nr.: see Label

EMC Conformance according to the Directive 89/336/EC

EN 50270: 2006 Type 2, EN 61000-6-3: 2007

5.4 Performance Specification

Combustible Gas

Range	0 to 100 % LEL or 0 to 5 % CH ₄
Resolution	1 % LEL or 0.05 % vol CH ₄
Reproducibility	3 % LEL, 0 % to 50 % LEL reading or 0.15 % CH ₄ , 0.00 % to 2.50 % CH ₄ [normal temperature range]
	5 % LEL, 50 % to 100 % LEL reading or 0.25 % CH ₄ , 2.50 % to 5.00 % CH ₄ [normal temperature range]
	5 % LEL, 0 % to 50 % LEL reading or 0.25 % CH ₄ , 0.00 % to 2.50 % CH ₄ [normal temperature range]
	8 % LEL, 50 % to 100 % LEL reading or 0.4 % CH ₄ , 2.50 % to 5.00 % CH ₄ [normal temperature range]
Response time	90 % of final reading in less than or equal to 25 sec [pentane] and 10 sec [methane] [normal temperature range]

Oxygen

The oxygen sensor has built-in temperature compensation. However, if temperature shifts dramatically, the oxygen sensor reading may shift. Zero the device at a temperature within 30 °C [86 °F] of the work place temperature for the least effect.

Range	0 to 30 vol.% O ₂
Resolution	0.1 vol.% O ₂
Reproducibility	0.7 vol.% O ₂ for 0 to 30 vol.% O ₂
Response time	<10 second [normal temperature range] [90% of final reading]

Carbon Monoxide



Data is presented as the indicated output in PPM which will result from the application of the test gas.

Range	0 - 999 ppm [0-999 mg/m ³] CO
Resolution	1 ppm [1.2 mg/m ³] CO,
Reproducibility	±5 ppm [5.8 mg/m ³] CO or 10 % of reading, whichever is greater [normal temperature range]
	±10 ppm [11.6 mg/m ³] CO or 20 % of reading, whichever is greater [extended temperature range]
Response time	90% of final reading in less than or equal to 15 seconds [normal temperature range]

Hydrogen Sulphide

Range	0 - 200 ppm [0 to 284 mg/m ³] H ₂ S
Resolution	1 ppm [1.4 mg/m ³] H ₂ S, for 3 to 200 ppm [4,3 to 284 mg/m ³] H ₂ S
Reproducibility	±2 ppm [2.8 mg/m ³] H ₂ S or 10 % of reading, whichever is greater [normal temperature range]
	0 to 100 ppm [0 to 142 mg/m ³] H ₂ S, ±5 ppm [7,1 mg/m ³] H ₂ S or 10 % of reading, whichever is greater [extended temperature range]
Response time	90% of final reading in less than or equal to 15 seconds [normal temperature range]

5.5 XCell Sensor Patents

Combustible sensor	Part No.10106722	Patent Pending
O ₂ sensor	Part No.10106729	Patent Pending

6 Ordering Information

Description	Part No.
SS Suspender Clip	10069894
58L quad gas mix [1.45% CH ₄ , 15% O ₂ , 60 ppm CO, 20 ppm H ₂ S]	10053022
Universal pump probe [UL]	10046528
Universal pump probe [CSA]	10055576
Universal pump probe [AUS]	10047594
Universal pump probe [ATEX]	10047596
Calibration assembly [cap, tube, connector]	10089321
Charging cradle assembly	10086638
North American Power Supply with Charge Connector	10092233
Global Power Supply with Charge Connector	10092938
Charging cradle assembly with Power supply [[North America]	10087368
Charging cradle assembly with Power supply [Australia]	10089487
Charging cradle assembly with Power supply [Europe]	10086638
Vehicle Charging cradle assembly	10095774
MSA Link Software CD-Rom	10088099
JetEye IR adapter with USB connector	10082834
Combustible sensor replacement kit	10106722
O ₂ sensor replacement kit	10106729
CO/H ₂ S Two Toxic sensor replacement kit	10106725
Single CO sensor replacement kit	10106724
Single H ₂ S sensor replacement kit	10106723
Front Housing with integrated dust filters [charcoal]	10110030
Front Housing with integrated dust filters [fluorescent]	10110029
Main board w/ battery pack	10089161
LCD Frame assembly [frame LCD, zebra strips, screws]	10110061
Sensors gasket, socket head cap screws [4x], self tapping [2x]	10110062
[2x] CD Manual ALTAIR 4 x	10106623



GALAXY, QuickCheck and additional accessories are available on request.

7 Appendix

7.1 Start Up Sequence [Power on]

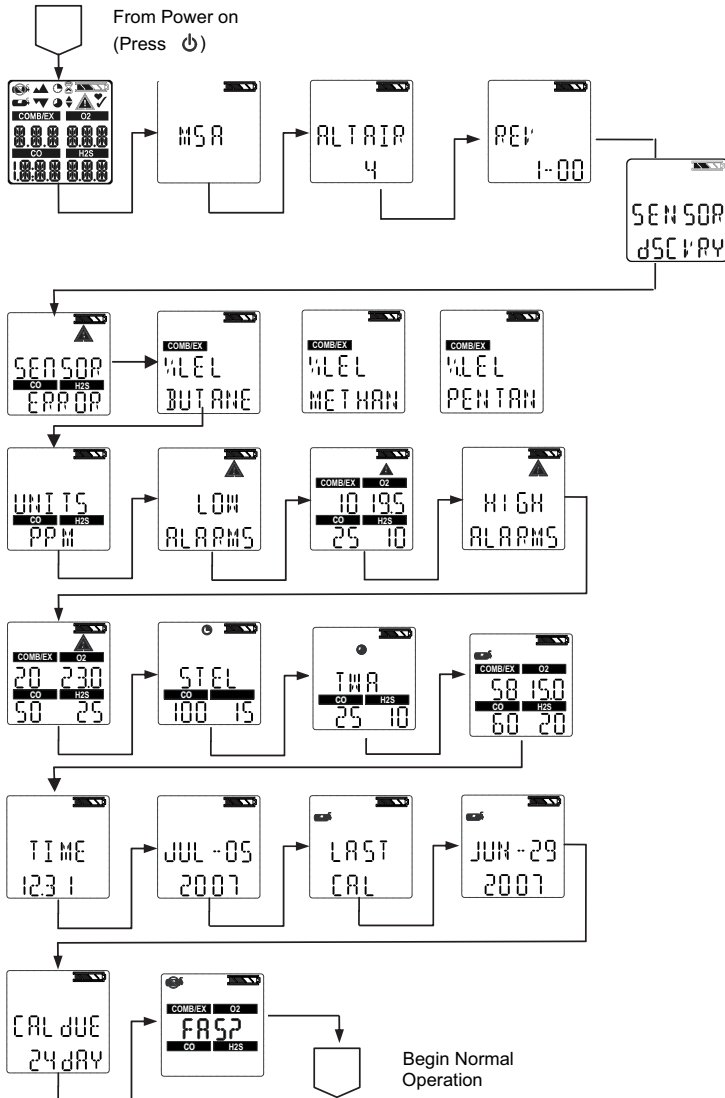

7.2 Fresh Air Setup [FAS]

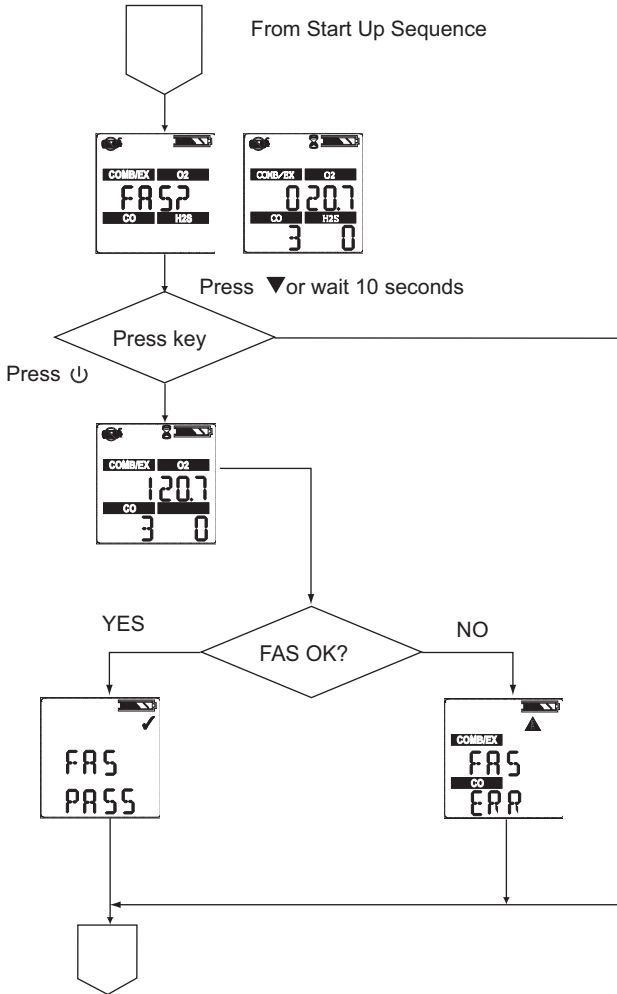

7.3 Reset Screen Controls

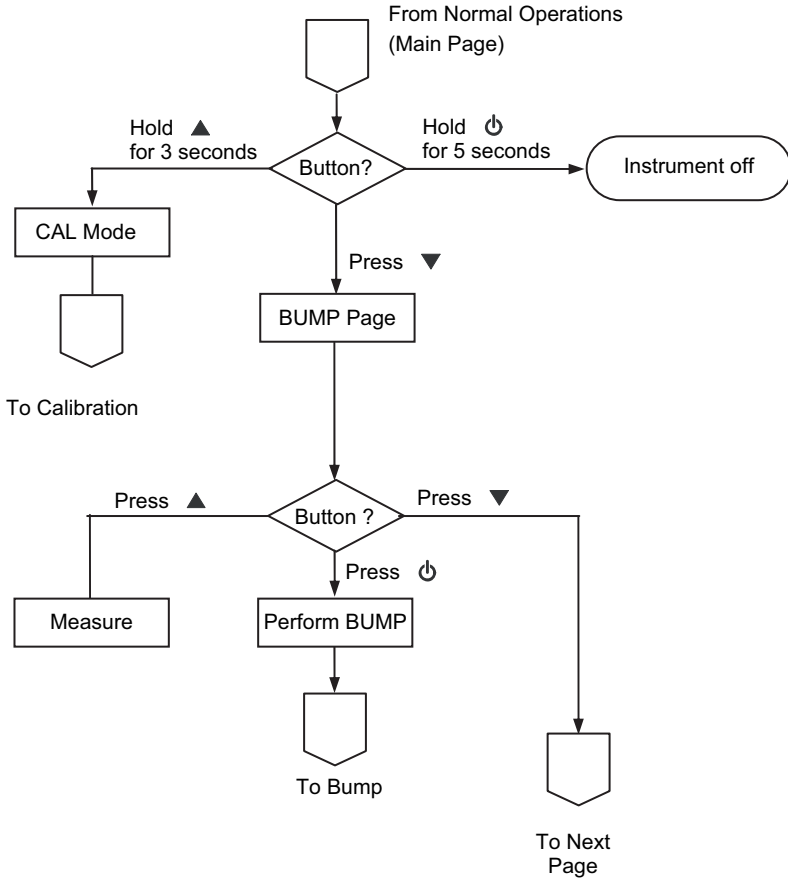

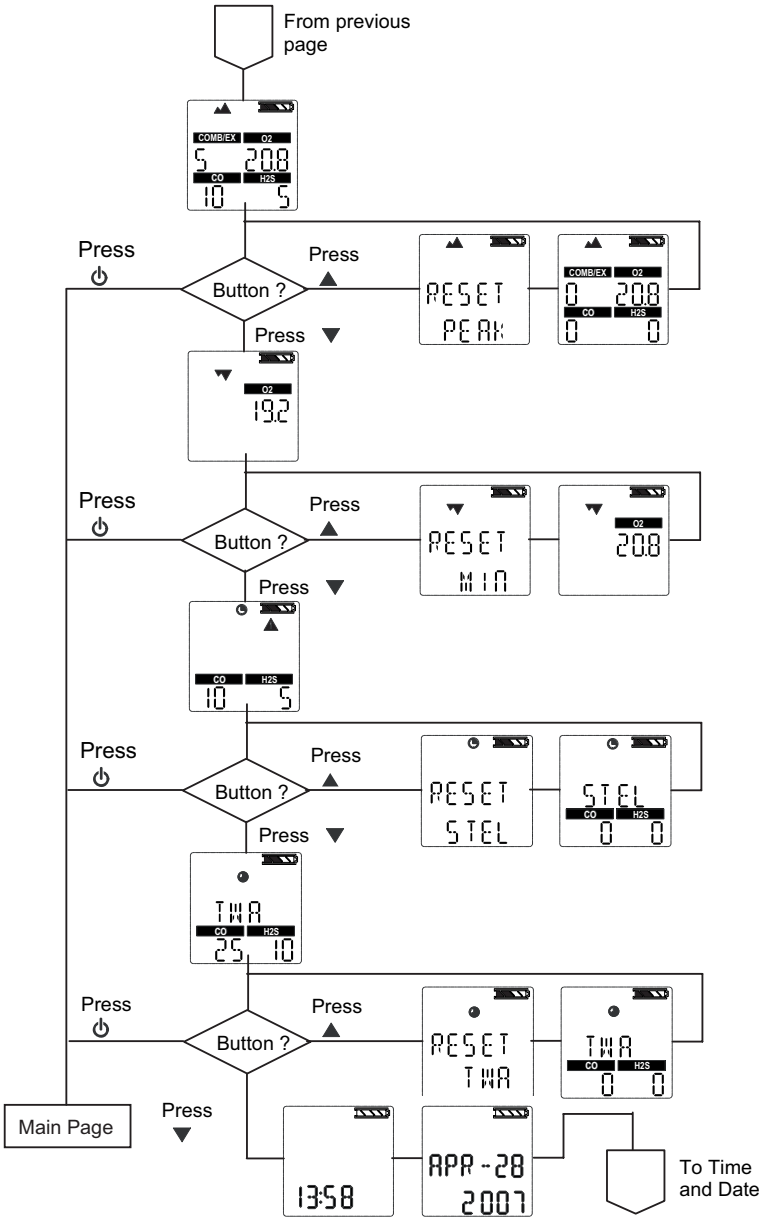

7.4 Bump Test

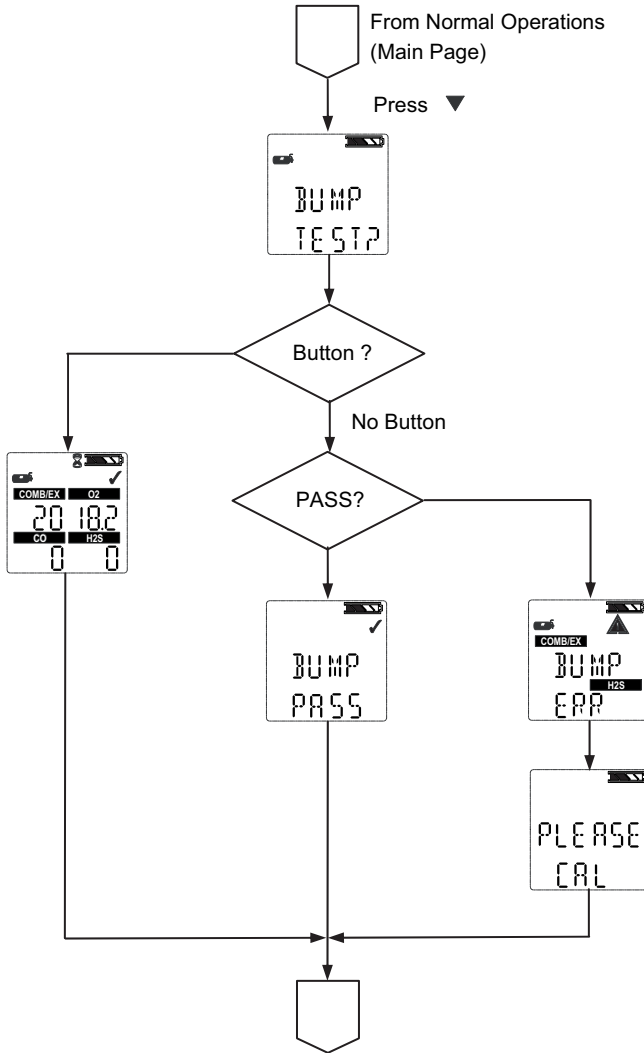

7.5 Options Setup

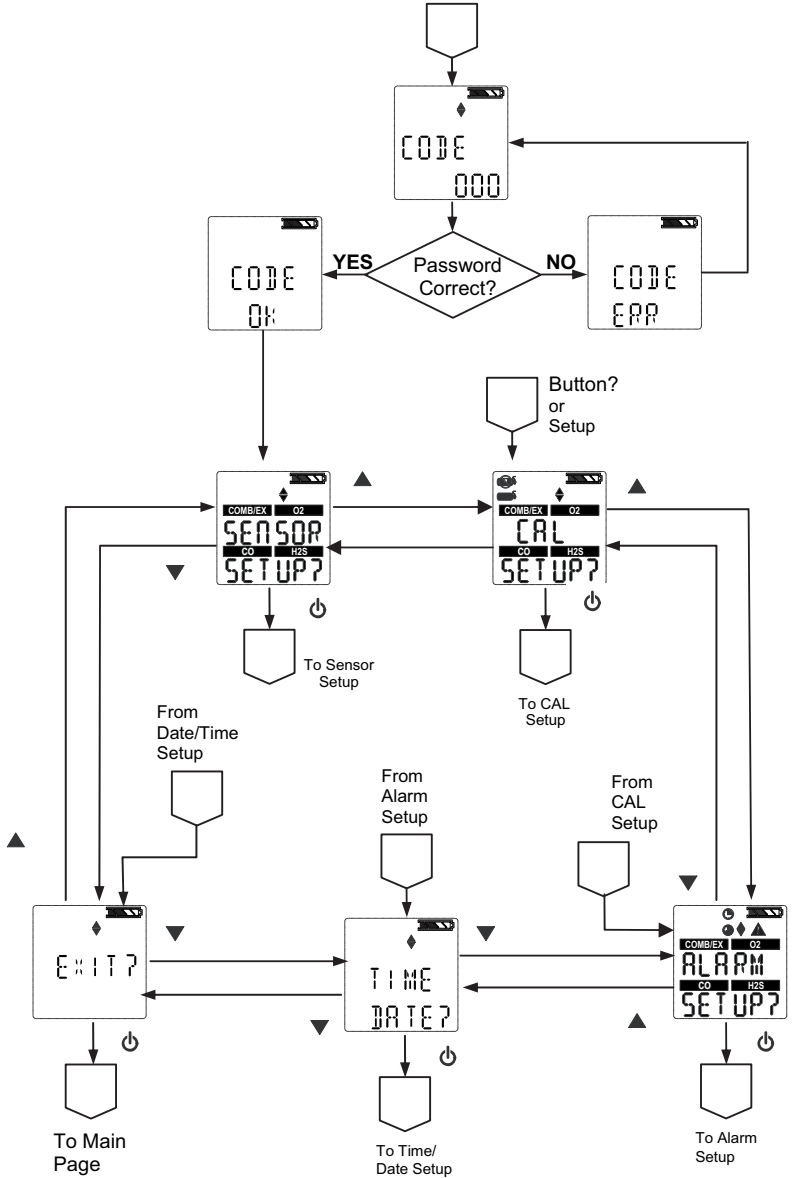

7.6 Sensor Setup

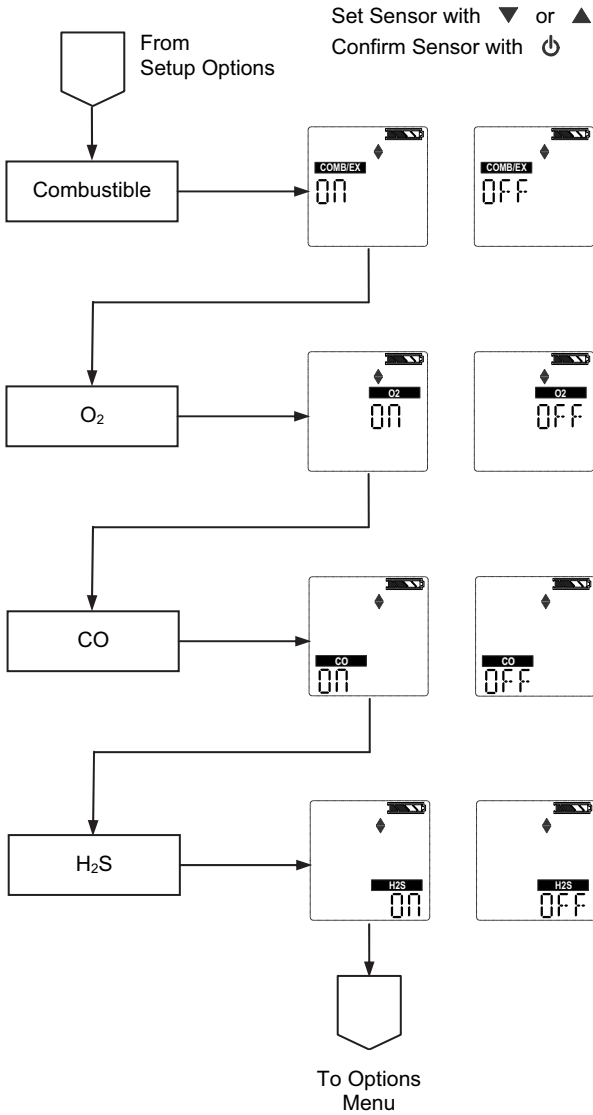

7.7 Calibrations

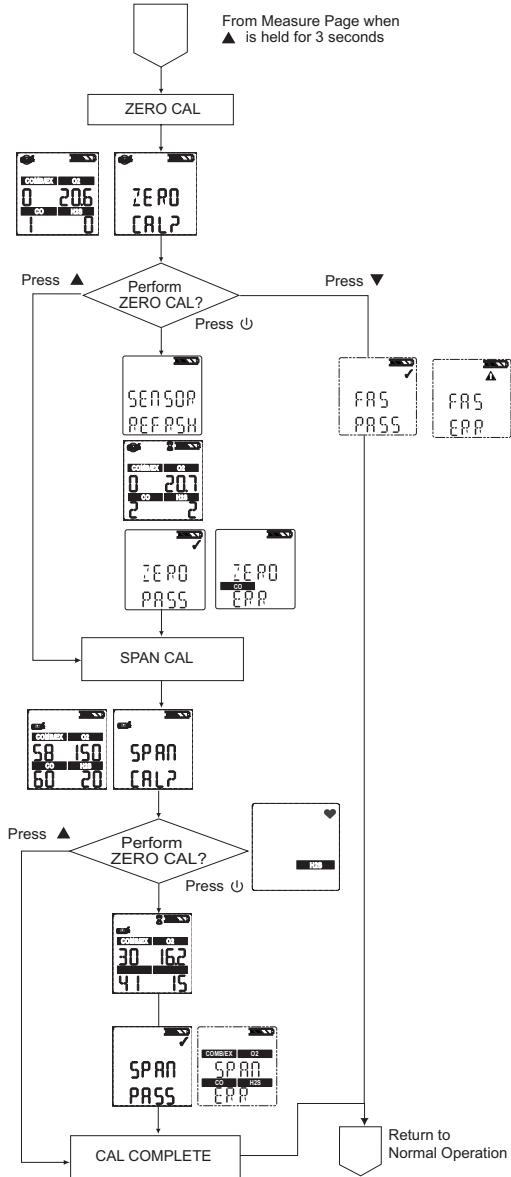

Alarm Setup

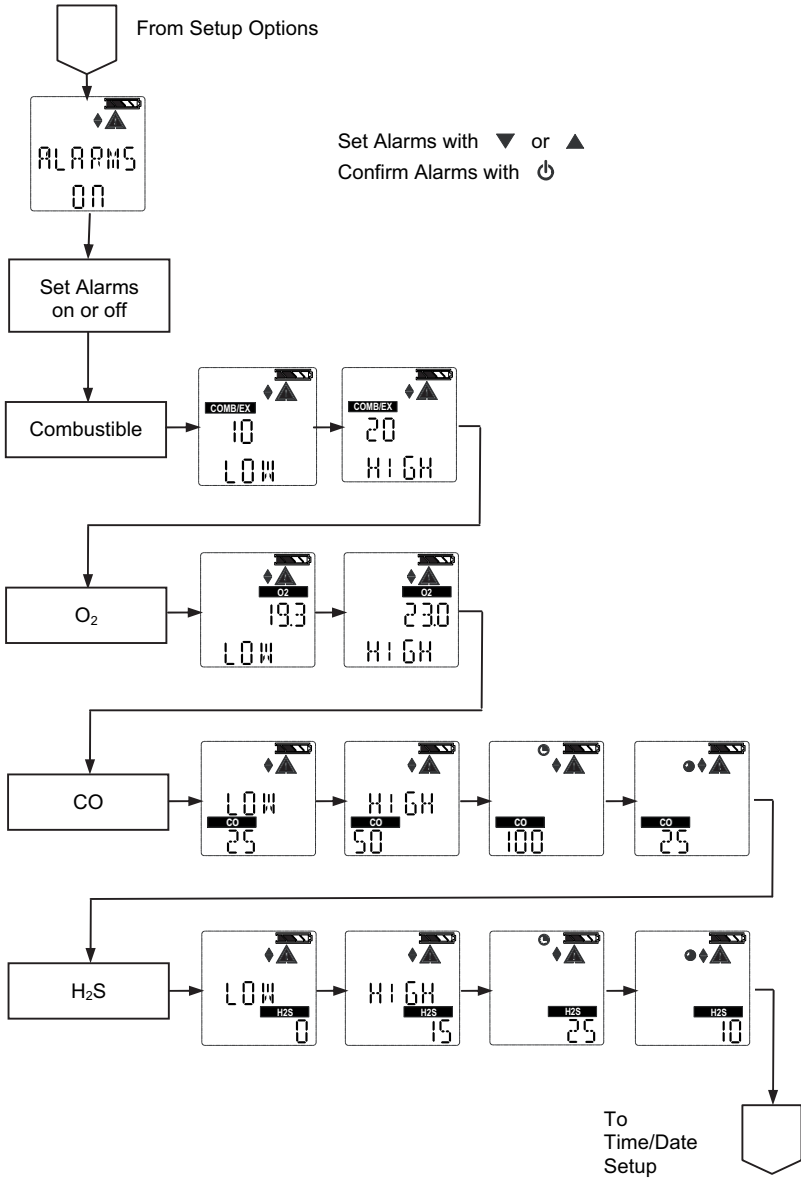

Time and Date Setup

