



## ▶ PNOZ s4

**PILZ**  
THE SPIRIT OF SAFETY

Operating Manual-21396-EN-21  
- Safety relays



This document is the original document.

Where unavoidable, for reasons of readability, the masculine form has been selected when formulating this document. We do assure you that all persons are regarded without discrimination and on an equal basis.

All rights to this documentation are reserved by Pilz GmbH & Co. KG. Copies may be made for the user's internal purposes. Suggestions and comments for improving this documentation will be gratefully received.

Pilz®, PIT®, PMI®, PNOZ®, Primo®, PSEN®, PSS®, PVIS®, SafetyBUS p®, SafetyEYE®, SafetyNET p®, the spirit of safety® are registered and protected trademarks of Pilz GmbH & Co. KG in some countries.



SD means Secure Digital

<b>Introduction</b> .....	<b>5</b>
Validity of documentation .....	5
Using the documentation .....	5
Definition of symbols .....	5
<b>Safety</b> .....	<b>6</b>
Intended use .....	6
Safety regulations .....	7
Safety assessment .....	7
Use of qualified personnel .....	7
Warranty and liability .....	7
Disposal .....	7
For your safety .....	8
<b>Unit features</b> .....	<b>8</b>
<b>Safety features</b> .....	<b>8</b>
<b>Block diagram/terminal configuration</b> .....	<b>9</b>
Unit types with UB 24 VDC .....	9
Unit types with UB 48 - 240 VAC/DC .....	9
<b>Function description</b> .....	<b>10</b>
Timing diagram .....	11
<b>Installation</b> .....	<b>11</b>
<b>Wiring</b> .....	<b>12</b>
<b>Preparing for operation</b> .....	<b>13</b>
Operating modes .....	13
Set operating modes .....	13
Connection .....	14
<b>Application examples</b> .....	<b>16</b>
<b>Operation</b> .....	<b>19</b>
Status indicators .....	19
Error indicators .....	20

<b>Faults - malfunctions</b> .....	<b>21</b>
<b>Dimensions in mm</b> .....	<b>21</b>
<b>Technical details Order no. 750104, 750134, 751104</b> .....	<b>22</b>
<b>Technical details Order no. 751134, 751184</b> .....	<b>29</b>
<b>Safety characteristic data</b> .....	<b>35</b>
<b>Classification according to ZVEI, CB24I</b> .....	<b>36</b>
<b>Supplementary data</b> .....	<b>37</b>
Service life graph .....	37
Permitted operating height .....	41
<b>Remove plug-in terminals</b> .....	<b>42</b>
<b>Order reference</b> .....	<b>42</b>
<b>EC declaration of conformity</b> .....	<b>42</b>
<b>UKCA-Declaration of Conformity</b> .....	<b>43</b>

## Introduction

### Validity of documentation

This documentation is valid for the product PNOZ s4. It is valid until new documentation is published.

This operating manual explains the function and operation, describes the installation and provides guidelines on how to connect the product.

### Using the documentation

This document is intended for instruction. Only install and commission the product if you have read and understood this document. The document should be retained for future reference.

### Definition of symbols

Information that is particularly important is identified as follows:



#### **DANGER!**

This warning must be heeded! It warns of a hazardous situation that poses an immediate threat of serious injury and death and indicates preventive measures that can be taken.



#### **WARNING!**

This warning must be heeded! It warns of a hazardous situation that could lead to serious injury and death and indicates preventive measures that can be taken.



#### **CAUTION!**

This refers to a hazard that can lead to a less serious or minor injury plus material damage, and also provides information on preventive measures that can be taken.



#### **NOTICE**

This describes a situation in which the product or devices could be damaged and also provides information on preventive measures that can be taken. It also highlights areas within the text that are of particular importance.

**INFORMATION**

This gives advice on applications and provides information on special features.

**Safety****Intended use**

The safety relay provides a safety-related interruption of a safety circuit.

The safety relay meets the requirements of EN 60947-5-1 and EN 60204-1 and may be used in applications with:

- ▶ E-STOP pushbuttons
- ▶ Safety gates
- ▶ Light grids and safety switches with detection of shorts across contacts

**Improper use**

The following is deemed improper use in particular

- ▶ Any component, technical or electrical modification to the product,
- ▶ Use of the product outside the areas described in this operating manual,
- ▶ Use of the product outside the technical details (see [Technical details](#) [ 22]).

**NOTICE****EMC-compliant electrical installation**

The product is designed for use in an industrial environment. The product may cause interference if installed in other environments. If installed in other environments, measures should be taken to comply with the applicable standards and directives for the respective installation site with regard to interference.

## Safety regulations

### Safety assessment

Before using a device, a safety assessment in accordance with the Machinery Directive is required.

The product as an individual component fulfils the functional safety requirements in accordance with EN ISO 13849 and EN 62061. However, this does not guarantee the functional safety of the overall plant/machine. To achieve the relevant safety level of the overall plant/machine's required safety functions, each safety function needs to be considered separately.

### Use of qualified personnel

The products may only be assembled, installed, programmed, commissioned, operated, maintained and decommissioned by persons who are competent to do so.

A competent person is a qualified and knowledgeable person who, because of their training, experience and current professional activity, has the specialist knowledge required. To be able to inspect, assess and operate devices, systems and machines, the person has to be informed of the state of the art and the applicable national, European and international laws, directives and standards.

It is the company's responsibility only to employ personnel who

- ▶ Are familiar with the basic regulations concerning health and safety / accident prevention,
- ▶ Have read and understood the information provided in the section entitled Safety
- ▶ Have a good knowledge of the generic and specialist standards applicable to the specific application.

### Warranty and liability

All claims to warranty and liability will be rendered invalid if

- ▶ The product was used contrary to the purpose for which it is intended,
- ▶ Damage can be attributed to not having followed the guidelines in the manual,
- ▶ Operating personnel are not suitably qualified,
- ▶ Any type of modification has been made (e.g. exchanging components on the PCB boards, soldering work etc.).

### Disposal

- ▶ In safety-related applications, please comply with the mission time  $T_M$  in the safety-related characteristic data.
- ▶ When decommissioning, please comply with local regulations regarding the disposal of electronic devices (e.g. Electrical and Electronic Equipment Act).

**For your safety**

The unit meets all the necessary conditions for safe operation. However, please note the following:

- ▶ Note for overvoltage category III: If voltages higher than low voltage (>50 VAC or >120 VDC) are present on the unit, connected control elements and sensors must have a rated insulation voltage of at least 250 V.

**Unit features**

- ▶ Positive-guided relay outputs:
  - 3 safety contacts (N/O), instantaneous
  - 1 auxiliary contact (N/C), instantaneous
- ▶ 1 semiconductor output
- ▶ Connection options for:
  - E-STOP pushbuttons
  - Safety gate limit switches
  - Start buttons
  - Light grids and safety switches with detection of shorts across contacts
- ▶ A connector can be used to connect 1 PNOZsigma contact expansion module
- ▶ Operating modes can be set via rotary switch
- ▶ LED indicator for:
  - Supply voltage
  - Input status, channel 1
  - Input status, channel 2
  - Switch status of the safety contacts
  - Start circuit
  - Errors
- ▶ Plug-in connection terminals (either spring-loaded terminal or screw terminal)
- ▶ See order reference for unit types

**Safety features**

The safety relay meets the following safety requirements:

- ▶ The circuit is redundant with built-in self-monitoring.
- ▶ The safety function remains effective in the case of a component failure.
- ▶ The correct opening and closing of the safety function relays is tested automatically in each on-off cycle.



## Block diagram/terminal configuration

### Unit types with UB 24 VDC

► U<sub>B</sub>: 24 VDC; Order no. 750104, 751104, 751184

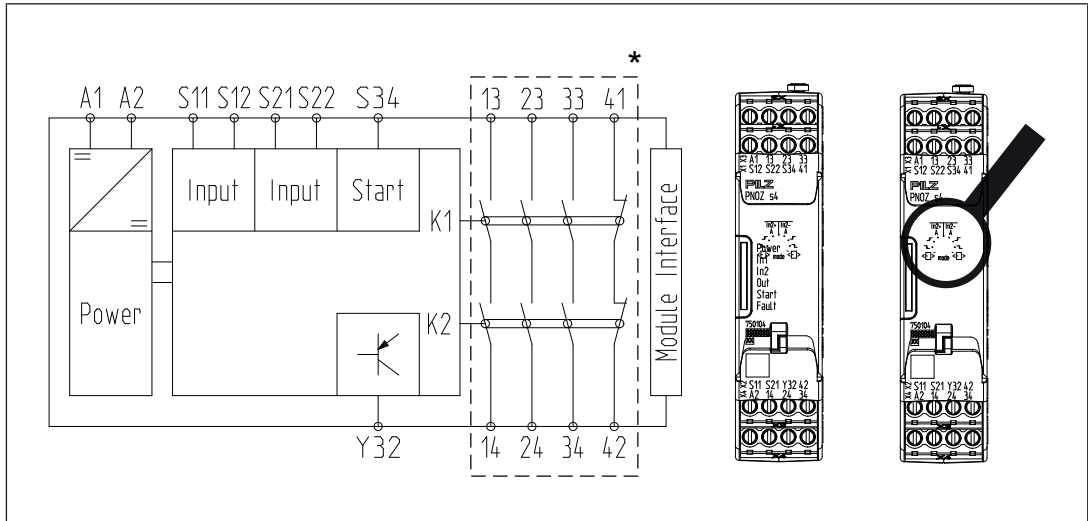

Fig.: Centre: Front view with cover, right: Front view without cover

\*Insulation between the non-marked area and the relay contacts: Basic insulation (over-voltage category III), Protective separation (overvoltage category II)

### Unit types with UB 48 - 240 VAC/DC

► U<sub>B</sub>: 48 - 240 VAC/DC; Order no. 750134, 751134

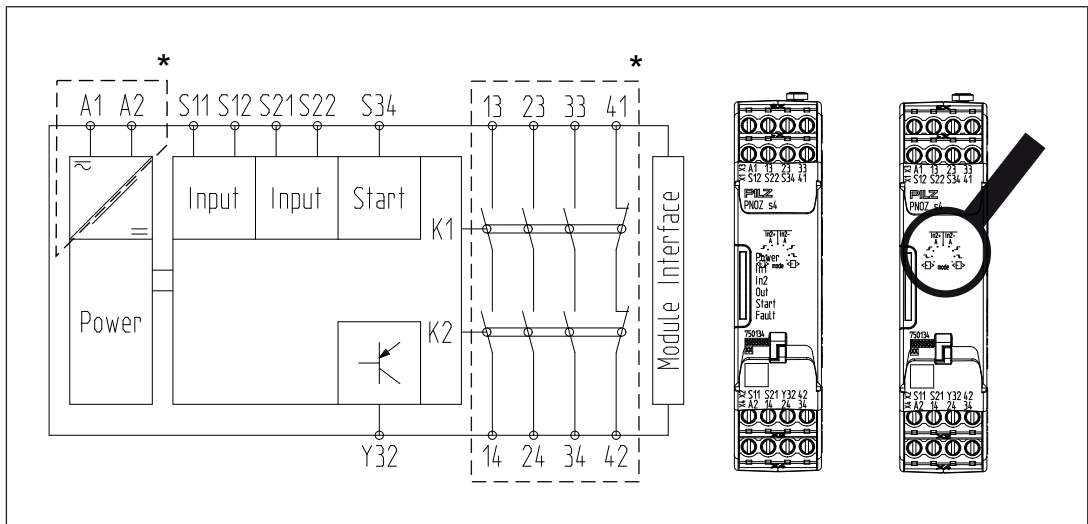





Fig.: Centre: Front view with cover, right: Front view without cover

\*Insulation between the non-marked area and the relay contacts: Basic insulation (over-voltage category III), Protective separation (overvoltage category II)

## Function description

- ▶  $\overline{\text{In2+}}$  Single-channel operation: no redundancy in the input circuit, earth faults in the start circuit and input circuit are detected.
- ▶ Dual-channel operation without detection of shorts across contacts: Redundant input circuit, detects PNOZ s4
  - earth faults in the start and input circuit,
  - short circuits in the input circuit and, with a monitored start, in the start circuit too.
- ▶  $\overline{\text{In2-}}$  Dual-channel operation with detection of shorts across contacts: Redundant input circuit, detects PNOZ s4
  - earth faults in the start and input circuit,
  - Short circuits in the input circuit and, with a monitored start, in the start circuit too,
  - Shorts across contacts in the input circuit.
- ▶ **A** Automatic start: Unit is active once the input circuit has been closed.
- ▶ Manual start Unit is active once the input circuit and the start circuit are closed.
- ▶  Monitored start with falling edge: Unit is active once
  - the input circuit is closed and then the start circuit is closed and opened again.
  - the start circuit is closed and then opened again once the input circuit is closed.
- ▶  Monitored start with rising edge: Unit is active once the input circuit is closed and once the start circuit is closed after the waiting period has elapsed (see technical details).
- ▶  Start with start-up test: The unit checks whether safety gates that are closed are opened and then closed again when supply voltage is applied.
- ▶ Increase in the number of available instantaneous safety contacts by connecting contact expander modules or external contactors/relays;  
A connector can be used to connect 1 PNOZsigma contact expansion module.

### Timing diagram

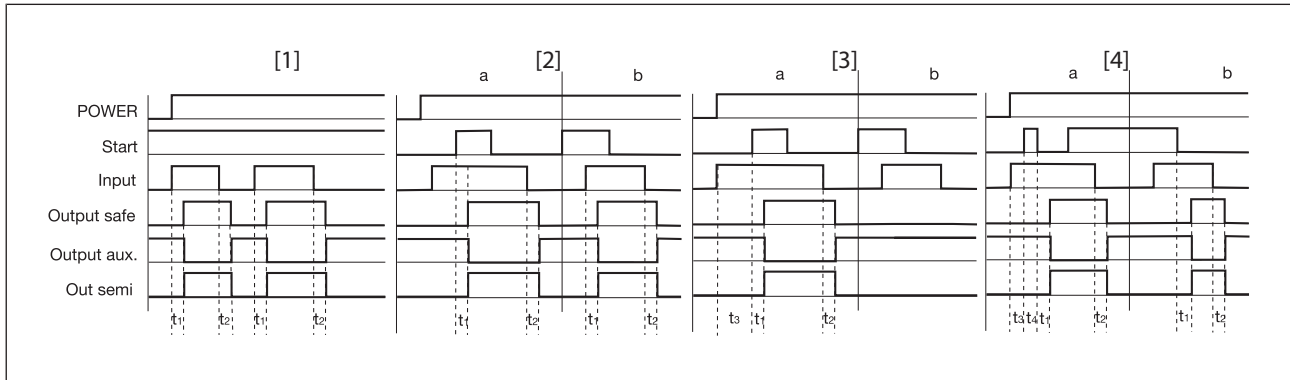

### Legend

- ▶ POWER: Supply voltage
- ▶ Start: Start circuit
- ▶ Input: Input circuit
- ▶ Output safe: Safety contacts
- ▶ Output aux: Auxiliary contacts
- ▶ Out semi: Semiconductor output
- ▶ [1]: Automatic start
- ▶ [2]: Manual start
- ▶ [3]: Monitored start with rising edge
- ▶ [4]: Monitored start with falling edge
- ▶ a: Input circuit closes before start circuit
- ▶ b: Start circuit closes before input circuit
- ▶  $t_1$ : Switch-on delay
- ▶  $t_2$ : Delay-on de-energisation
- ▶  $t_3$ : Waiting period with a monitored start
- ▶  $t_4$ : Min. start pulse duration with a monitored start

### Installation

#### Install base unit without contact expansion module:

- ▶ Ensure that the plug terminator is inserted at the side of the unit.

#### Connect base unit and PNOZsigma contact expansion module:

- ▶ Remove the plug terminator at the side of the base unit and at the contact expansion module.
- ▶ Connect the base unit and the contact expansion module to the supplied connector before mounting the units to the DIN rail.

#### Installation in control cabinet

- ▶ The safety relay should be installed in a control cabinet with a protection type of at least IP54.
- ▶ Use the notch on the rear of the unit to attach it to a DIN rail (35 mm).

- ▶ When installed vertically: Secure the unit by using a fixing element (e.g. retaining bracket or end angle).
- ▶ Push the device upwards or downwards before lifting it from the DIN rail.

## Wiring

Please note:

- ▶ Information given in the "[Technical details \[22\]](#)" must be followed.
- ▶ Outputs 13-14, 23-24, 33-34 are safety contacts; output 41-42 is an auxiliary contact (e.g. for display).
- ▶ Auxiliary contact 41-42 and semiconductor output Y32 should **not** be used for safety circuits!
- ▶ To prevent contact welding, a fuse should be connected before the output contacts (see [Technical details \[22\]](#)).
- ▶ Calculation of the max. cable length  $l_{\max}$  in the input circuit:

$$l_{\max} = \frac{R_{l_{\max}}}{R_l / \text{km}}$$

$R_{l_{\max}}$  = max. overall cable resistance (see [Technical details \[22\]](#))

$R_l / \text{km}$  = cable resistance/km

- ▶ Use copper wiring with a temperature stability of 75 °C.
- ▶ To prevent EMC interferences (particularly common-mode interferences) the measures described in EN 60204-1 must be executed. This includes the separate routing of cables of the control circuits (input, start and feedback loop) from other cables for energy transmission or the shielding of cables, for example.
- ▶ Adequate protection must be provided on all output contacts with capacitive and inductive loads.
- ▶ With  $U_B$  48 – 240 VAC/DC: Connect S21 to the functional earth.
- ▶ When connecting magnetically operated, reed proximity switches, ensure that the max. peak inrush current (on the input circuit) does not overload the proximity switch.
- ▶ On 24 VDC devices:  
The power supply must comply with the regulations for extra low voltages with protective electrical separation (SELV, PELV) in accordance with VDE 0100, Part 410.



### NOTICE

If you connect contact expansion modules to a base unit with a universal power supply, you will need to limit the conventional thermal current at the contact expansion modules' safety contacts to 70 % of the stated current (see technical details for contact expansion module).

## Preparing for operation

### Operating modes

The operating mode is set via the rotary switch on the unit. You can do this by opening the cover on the front of the unit.



#### NOTICE

Always carry out the following steps before the unit is set for the first time and with each change of the rotary switch.

#### Check that the rotary switch locks into position correctly:

- ▶ Turn the rotary switch as far as it will go to the left and right.
- ▶ Check the click sound and "click feel" in each individual position.

When you bring the rotary switch to the desired position, make sure that the rotary switch locks in position (click feel). The actual lock-in position may vary slightly from the labelling, as there are minor manufacturing tolerances.

#### Set operating modes

- ▶ Switch off supply voltage.
- ▶ Select operating mode via the operating mode selector switch "mode".
- ▶ If the operating mode selector switch "mode" is in its start position (vertical position), an error message will appear.

Operating mode selector switch "mode"	Automatic or manual start	Monitored start rising edge	Monitored start falling edge	Automatic start with start-up test
Without detection of shorts across contacts				
With detection of shorts across contacts				



#### NOTICE

Do not adjust the rotary switch during operation, otherwise an error message will appear, the safety contacts will open and the unit will not be ready for operation until the supply voltage has been switched off and then on again.

Connection

Supply voltage	Unit types with $U_B$ 24 VDC	Unit types with $U_B$ 48 - 240 VAC/DC

Input circuit	Single-channel	Dual-channel
Emergency stop <b>without</b> detection of shorts across contacts		
Emergency stop <b>with</b> detection of shorts across contacts		
Safety gate <b>without</b> detection of shorts across contacts		
Safety gate <b>with</b> detection of shorts across contacts		
Light beam device or safety switch, detection of shorts across contacts via ESPE, operating mode selector switch in the position "without detection of shorts across contacts" (only for unit types with $U_B = 24$ VDC)		



**NOTICE**

With single-channel wiring the safety level of your machine/plant may be lower than the safety level of the unit (see [Safety characteristic data \[35\]](#)).



**NOTICE**

When operated with a light grid or sensor

- It must not be possible to switch off the supply voltage for the PNOZsigma separately from the supply voltage for the light grid or safety switch.
- The operating mode selector switch must be set to "Without detection of shorts across contacts", as shorts across contacts are detected by the ESPE.

Start circuit/feedback loop	Without feedback loop monitoring	with feedback loop monitoring
Automatic start		
Monitored, manual start/restart		



**NOTICE**



**In the event of an automatic start or manual start with bridged start contact (fault):**

The unit starts up automatically when the safeguard is reset, e.g. when the E-STOP pushbutton is released. Use external circuit measures to prevent an unexpected restart.

Unit types with U <sub>B</sub> 24 VDC	Unit types with U <sub>B</sub> 48 - 240 VAC/DC
<p>*Connect together the 0V connections on all the external power supplies</p>	

**Legend**

- ▶ S1/S2: E-STOP/safety gate switch
- ▶ S3: Reset button
- ▶ ⤴: Switch operated

- ▶ : Gate open
- ▶ : Gate closed

## Application examples

### Emergency stop

- ▶ Dual-channel
- ▶ with detection of shorts across contacts
- ▶ Monitored start
- ▶ falling edge with feedback loop monitoring

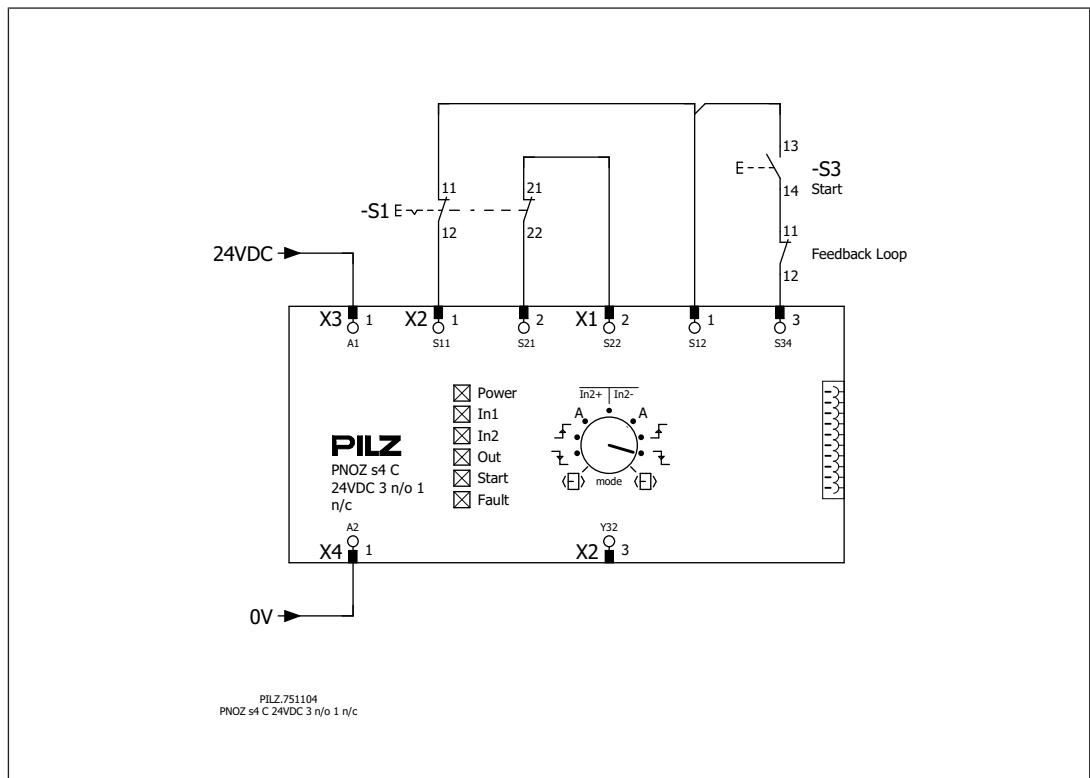



### Safety gate

- ▶ Dual-channel
- ▶ with detection of shorts across contacts
- ▶ Monitored start
- ▶ falling edge with feedback loop monitoring

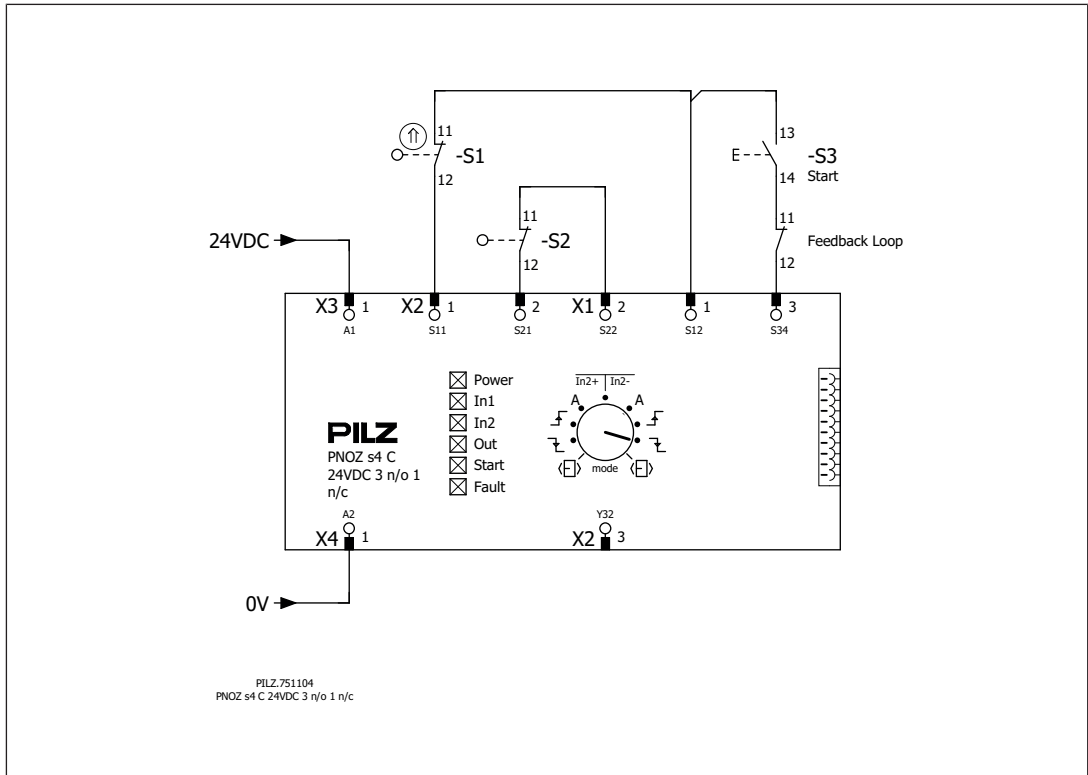

**OSSD signals**

- ▶ Dual-channel
- ▶ without detection of shorts across contacts of PNOZ - detection of shorts across contacts by sensor technology
- ▶ Automatic start
- ▶ with feedback loop monitoring

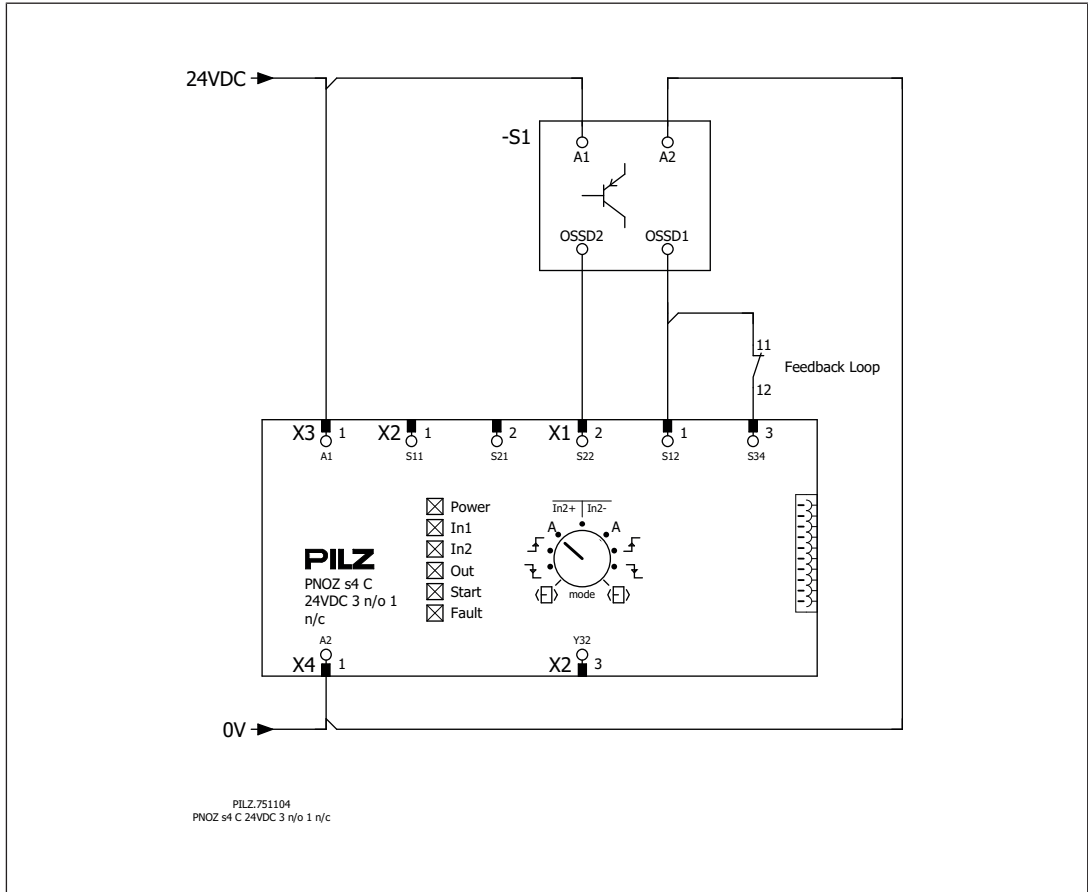

## Operation

When the relay outputs are switched on, the mechanical contact on the relay cannot be tested automatically. Depending on the operational environment, measures to detect the non-opening of switching elements may be required under some circumstances.

When the product is used in accordance with the European Machinery Directive, a check must be carried out to ensure that the safety contacts on the relay outputs open correctly. Open the safety contacts (switch off output) and start the device again, so that the internal diagnostics can check that the safety contacts open correctly

- ▶ for SIL CL 3/PL e at least 1x per month
- ▶ for SIL CL 2/PL d at least 1x per year



### NOTICE

The safety functions should be checked after initial commissioning and each time the plant/machine is changed. The safety functions may only be checked by qualified personnel.

The unit is ready for operation when the Power LED is permanently lit.

LEDs indicate the status and errors during operation:

- LED on
- LED flashes
- LED off



### INFORMATION

Status indicators and error indicators may occur independently. In the case of an error display, the "Fault" LED will light or flash (exception: "Supply voltage too low"). An LED that is also flashing indicates the potential cause of the error. An LED that is lit and is static indicates a normal operating status. Several status indicators and error indicators may occur simultaneously.

### Status indicators

- POWER**  
Supply voltage is present.
- IN1**  
Input circuit at S12 is closed.
- IN2**  
Input circuit at S22 is closed.
- OUT**  
Safety contacts are closed and semiconductor output Y32 carries a high signal.
- START**  
24 VDC is present at S34.

### Error indicators



#### All LEDs off

Diagnostics: Short across contacts/earth fault; unit switched off

- ▶ Remedy: Rectify short across contacts/earth fault, switch off supply voltage for 1 min.



#### FAULT

Diagnostics: Plug terminator not connected

- ▶ Remedy: Insert plug terminator, switch supply voltage off and then on again.



#### FAULT

Diagnostics: Internal error, unit defective

- ▶ Remedy: Switch supply voltage off and then on again, change unit if necessary.



#### POWER

Diagnostics: Supply voltage too low

- ▶ Remedy: Check supply voltage and increase if necessary.



#### IN1, IN2 alternately



#### FAULT

Diagnostics: Connection error (possibly: cable resistance in the input circuit is too high) or short detected between S12 and S22

- ▶ Remedy: Rectify connection error or short across contacts, switch supply voltage off and then on again.



#### IN1



#### FAULT

Diagnostics: Power-up blocked due to short-term interruption at S12; channels in the input circuit not opened simultaneously.

- ▶ Remedy: Open S11-S12 and S21-S22 simultaneously and then close again.



#### IN2



#### FAULT

Diagnostics: Power-up blocked due to short-term interruption at S22; channels in the input circuit not opened simultaneously.

- ▶ Remedy: Open S11-S12 and S21-S22 simultaneously and then close again.



**IN1, IN2 simultaneously FAULT**



Diagnostics: Power-up blocked due to short-term interruption at S12 and S22; channels in the input circuit not opened simultaneously.

► Remedy: Open S11-S12 and S21-S22 simultaneously and then close again.



**START FAULT**



Diagnostics: Position of rotary switch is not permitted or rotary switch was adjusted during operation.

► Remedy: Switch supply voltage off and then on again.



**POWER, IN1, IN2, OUT, START, FAULT**

Diagnostics: The operating mode selector switch "mode" is in its start position (vertical position)

► Remedy: Switch off the supply voltage and set the required operating mode on operating mode selector switch "mode".

**Faults - malfunctions**

► Contact malfunctions: If the contacts have welded, reactivation will not be possible after the input circuit has opened.

**Dimensions in mm**

\*with spring-loaded terminals

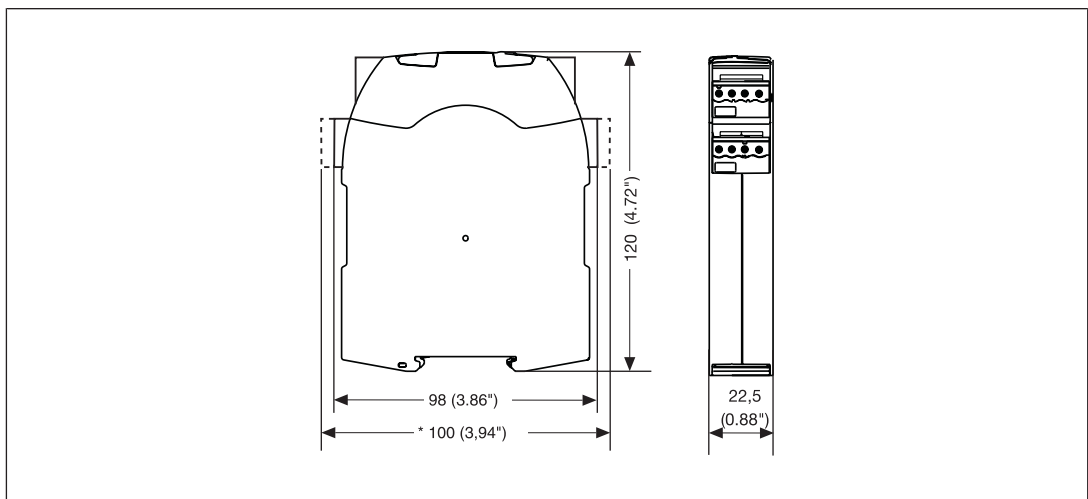

### Technical details Order no. 750104, 750134, 751104

General	750104	750134	751104
Certifications	CCC, CE, EAC, KOSHA, TÜV, UKCA, cULus Listed	CCC, CE, EAC, KOSHA, TÜV, UKCA, cULus Listed	CCC, CE, EAC, KOSHA, TÜV, UKCA, cULus Listed
Electrical data	750104	750134	751104
Supply voltage			
Voltage	24 V	48 - 240 V	24 V
Kind	DC	AC/DC	DC
Voltage tolerance	-15 %/+10 %	-15 %/+10 %	-15 %/+10 %
Output of external power supply (AC)	–	5 VA	–
Output of external power supply (DC)	2,5 W	2,5 W	2,5 W
Frequency range AC	–	50 - 60 Hz	–
Residual ripple DC	20 %	160 %	20 %
Duty cycle	100 %	100 %	100 %
Max. inrush current impulse			
Current pulse, A1	0,5 A	–	0,5 A
Pulse duration, A1	5 ms	–	5 ms
Inputs	750104	750134	751104
Quantity	2	2	2
Voltage at			
Input circuit DC	24 V	24 V	24 V
Start circuit DC	24 V	24 V	24 V
Feedback loop DC	24 V	24 V	24 V
Current at			
Input circuit DC	50 mA	50 mA	50 mA
Start circuit DC	50 mA	50 mA	50 mA
Feedback loop DC	50 mA	50 mA	50 mA
Max. inrush current impulse			
Current pulse, input circuit	0,2 A	0,2 A	0,2 A
Pulse duration, input circuit	100 ms	100 ms	100 ms
Current pulse, feedback loop	0,2 A	0,2 A	0,2 A
Pulse duration, feedback loop	15 ms	15 ms	15 ms
Current pulse, start circuit	0,2 A	0,2 A	0,2 A
Pulse duration, start circuit	15 ms	15 ms	15 ms
Min. input resistance at power-on	110 Ohm	110 Ohm	110 Ohm

<b>Inputs</b>	<b>750104</b>	<b>750134</b>	<b>751104</b>
Max. overall cable resistance R <sub>lmax</sub>			
Single-channel at UB DC	<b>30 Ohm</b>	<b>30 Ohm</b>	<b>30 Ohm</b>
Single-channel at UB AC	–	<b>30 Ohm</b>	–
Dual-channel without detection of shorts across contacts at UB DC	<b>60 Ohm</b>	<b>30 Ohm</b>	<b>60 Ohm</b>
Dual-channel without detection of shorts across contacts at UB AC	–	<b>30 Ohm</b>	–
Dual-channel with detection of shorts across contacts at UB DC	<b>30 Ohm</b>	<b>30 Ohm</b>	<b>30 Ohm</b>
Dual-channel with detection of shorts across contacts at UB AC	–	<b>30 Ohm</b>	–
<b>Semiconductor outputs</b>	<b>750104</b>	<b>750134</b>	<b>751104</b>
Quantity	<b>1</b>	<b>1</b>	<b>1</b>
Voltage	<b>24 V</b>	<b>24 V</b>	<b>24 V</b>
Current	<b>20 mA</b>	<b>20 mA</b>	<b>20 mA</b>
Residual current at "0" signal	<b>0,1 mA</b>	<b>0,1 mA</b>	<b>0,1 mA</b>
Max. internal voltage drop	<b>5 V</b>	–	<b>5 V</b>
Conditional rated short circuit current	<b>100 A</b>	<b>100 A</b>	<b>100 A</b>
Lowest operating current	<b>0 mA</b>	<b>0 mA</b>	<b>0 mA</b>
Utilisation category in accordance with EN 60947-1	<b>DC-12</b>	<b>DC-12</b>	<b>DC-12</b>
<b>Relay outputs</b>	<b>750104</b>	<b>750134</b>	<b>751104</b>
Number of output contacts			
Safety contacts (N/O), instantaneous	<b>3</b>	<b>3</b>	<b>3</b>
Auxiliary contacts (N/C)	<b>1</b>	<b>1</b>	<b>1</b>
Max. short circuit current I <sub>K</sub>	<b>1 kA</b>	<b>1 kA</b>	<b>1 kA</b>
Utilisation category in accordance with the standard	<b>EN 60947-4-1</b>	<b>EN 60947-4-1</b>	<b>EN 60947-4-1</b>

<b>Relay outputs</b>	<b>750104</b>	<b>750134</b>	<b>751104</b>
Utilisation category of safety contacts			
AC1 at	<b>240 V</b>	<b>240 V</b>	<b>240 V</b>
Min. current	<b>0,003 A</b>	<b>0,003 A</b>	<b>0,003 A</b>
Max. current	<b>6 A</b>	<b>6 A</b>	<b>6 A</b>
Min. power	<b>0,04 VA</b>	<b>0,04 VA</b>	<b>0,04 VA</b>
Max. power	<b>1500 VA</b>	<b>1500 VA</b>	<b>1500 VA</b>
DC1 at	<b>24 V</b>	<b>24 V</b>	<b>24 V</b>
Min. current	<b>0,003 A</b>	<b>0,003 A</b>	<b>0,003 A</b>
Max. current	<b>6 A</b>	<b>6 A</b>	<b>6 A</b>
Min. power	<b>0,04 W</b>	<b>0,04 W</b>	<b>0,04 W</b>
Max. power	<b>150 W</b>	<b>150 W</b>	<b>150 W</b>
Utilisation category of auxiliary contacts			
AC1 at	<b>240 V</b>	<b>240 V</b>	<b>240 V</b>
Min. current	<b>0,003 A</b>	<b>0,003 A</b>	<b>0,003 A</b>
Max. current	<b>6 A</b>	<b>6 A</b>	<b>6 A</b>
Min. power	<b>0,04 VA</b>	<b>0,04 VA</b>	<b>0,04 VA</b>
Max. power	<b>1500 VA</b>	<b>1500 VA</b>	<b>1500 VA</b>
DC1 at	<b>24 V</b>	<b>24 V</b>	<b>24 V</b>
Min. current	<b>0,003 A</b>	<b>0,003 A</b>	<b>0,003 A</b>
Max. current	<b>6 A</b>	<b>6 A</b>	<b>6 A</b>
Min. power	<b>0,04 W</b>	<b>0,04 W</b>	<b>0,04 W</b>
Max. power	<b>150 W</b>	<b>150 W</b>	<b>150 W</b>
Utilisation category in accordance with the standard			
	<b>EN 60947-5-1</b>	<b>EN 60947-5-1</b>	<b>EN 60947-5-1</b>
Utilisation category of safety contacts			
AC15 at	<b>230 V</b>	<b>230 V</b>	<b>230 V</b>
Max. current	<b>5 A</b>	<b>3 A</b>	<b>5 A</b>
DC13 (6 cycles/min) at	<b>24 V</b>	<b>24 V</b>	<b>24 V</b>
Max. current	<b>5 A</b>	<b>4 A</b>	<b>5 A</b>
Utilisation category of auxiliary contacts			
AC15 at	<b>230 V</b>	<b>230 V</b>	<b>230 V</b>
Max. current	<b>5 A</b>	<b>3 A</b>	<b>5 A</b>
DC13 (6 cycles/min) at	<b>24 V</b>	<b>24 V</b>	<b>24 V</b>
Max. current	<b>5 A</b>	<b>4 A</b>	<b>5 A</b>
Utilisation category in accordance with UL			
Voltage	<b>240 V AC G.U. (same polarity)</b>	<b>240 V AC G.U. (same polarity)</b>	<b>240 V AC G.U. (same polarity)</b>
with current	<b>6 A</b>	<b>6 A</b>	<b>6 A</b>
Voltage	<b>24 V DC G. U.</b>	<b>24 V DC G. U.</b>	<b>24 V DC G. U.</b>
with current	<b>6 A</b>	<b>6 A</b>	<b>6 A</b>



<b>Relay outputs</b>	<b>750104</b>	<b>750134</b>	<b>751104</b>
External contact fuse protection, safety contacts			
in accordance with the standard	<b>EN 60947-5-1</b>	<b>EN 60947-5-1</b>	<b>EN 60947-5-1</b>
Max. melting integral	<b>260 A<sup>2</sup>s</b>	<b>66 A<sup>2</sup>s</b>	<b>260 A<sup>2</sup>s</b>
Blow-out fuse, quick	<b>10 A</b>	<b>6 A</b>	<b>10 A</b>
Blow-out fuse, slow	<b>6 A</b>	<b>4 A</b>	<b>6 A</b>
Blow-out fuse, gG	<b>10 A</b>	<b>6 A</b>	<b>10 A</b>
Circuit breaker 24V AC/DC, characteristic B/C	<b>6 A</b>	<b>4 A</b>	<b>6 A</b>
External contact fuse protection, auxiliary contacts			
Max. melting integral	<b>160 A<sup>2</sup>s</b>	<b>66 A<sup>2</sup>s</b>	<b>160 A<sup>2</sup>s</b>
Blow-out fuse, quick	<b>10 A</b>	<b>6 A</b>	<b>10 A</b>
Blow-out fuse, slow	<b>6 A</b>	<b>4 A</b>	<b>6 A</b>
Blow-out fuse, gG	<b>6 A</b>	<b>6 A</b>	<b>6 A</b>
Circuit breaker, 24 V AC/DC, characteristic B/C	<b>6 A</b>	<b>4 A</b>	<b>6 A</b>
Contact material	<b>AgCuNi + 0,2 µm Au</b>	<b>AgCuNi + 0,2 µm Au</b>	<b>AgCuNi + 0,2 µm Au</b>
<b>Conventional thermal current while loading several contacts</b>	<b>750104</b>	<b>750134</b>	<b>751104</b>
I <sub>th</sub> per contact at UB AC; AC1: 240 V, DC1: 24 V			
Conv. therm. current with 1 contact	–	<b>6 A</b>	–
Conv. therm. current with 2 contacts	–	<b>6 A</b>	–
Conv. therm. current with 3 contacts	–	<b>4,5 A</b>	–
I <sub>th</sub> per contact at UB DC; AC1: 240 V, DC1: 24 V			
Conv. therm. current with 1 contact	<b>6 A</b>	<b>6 A</b>	<b>6 A</b>
Conv. therm. current with 2 contacts	<b>6 A</b>	<b>6 A</b>	<b>6 A</b>
Conv. therm. current with 3 contacts	<b>5 A</b>	<b>4,5 A</b>	<b>5 A</b>

<b>Times</b>	<b>750104</b>	<b>750134</b>	<b>751104</b>
<b>Switch-on delay</b>			
with automatic start typ.	<b>170 ms</b>	<b>170 ms</b>	<b>170 ms</b>
with automatic start max.	<b>300 ms</b>	<b>300 ms</b>	<b>300 ms</b>
with automatic start after power on typ.	<b>350 ms</b>	<b>350 ms</b>	<b>350 ms</b>
with automatic start after power on max.	<b>600 ms</b>	<b>600 ms</b>	<b>600 ms</b>
with manual start typ.	<b>40 ms</b>	<b>40 ms</b>	<b>40 ms</b>
with manual start max.	<b>300 ms</b>	–	<b>300 ms</b>
with monitored start with rising edge typ.	<b>35 ms</b>	<b>35 ms</b>	<b>35 ms</b>
with monitored start with rising edge max.	<b>50 ms</b>	<b>50 ms</b>	<b>50 ms</b>
with monitored start with falling edge typ.	<b>55 ms</b>	<b>55 ms</b>	<b>55 ms</b>
with monitored start with falling edge max.	<b>70 ms</b>	<b>70 ms</b>	<b>70 ms</b>
<b>Delay-on de-energisation</b>			
with E-STOP typ.	<b>10 ms</b>	<b>10 ms</b>	<b>10 ms</b>
with E-STOP max.	<b>20 ms</b>	<b>20 ms</b>	<b>20 ms</b>
with power failure typ.	<b>40 ms</b>	<b>40 ms</b>	<b>40 ms</b>
with power failure max.	<b>80 ms</b>	–	<b>80 ms</b>
<b>Recovery time at max. switching frequency 1/s</b>			
after E-STOP	<b>100 ms</b>	<b>50 ms</b>	<b>100 ms</b>
after power failure	<b>100 ms</b>	<b>100 ms</b>	<b>100 ms</b>
<b>Waiting period with a monitored start</b>			
with rising edge	<b>120 ms</b>	<b>120 ms</b>	<b>120 ms</b>
with falling edge	<b>250 ms</b>	<b>150 ms</b>	<b>250 ms</b>
<b>Min. start pulse duration with a monitored start</b>			
with falling edge	<b>100 ms</b>	<b>100 ms</b>	<b>100 ms</b>
with rising edge	<b>30 ms</b>	<b>30 ms</b>	<b>30 ms</b>
<b>Supply interruption before de-energisation</b>			
	<b>20 ms</b>	<b>20 ms</b>	<b>20 ms</b>
<b>Simultaneity, channel 1 and 2 max.</b>			
	∞	∞	∞
<b>Environmental data</b>			
<b>Climatic suitability</b>	<b>EN 60068-2-78</b>	<b>EN 60068-2-78</b>	<b>EN 60068-2-78</b>
<b>Ambient temperature</b>			
Temperature range	<b>-10 - 55 °C</b>	<b>-10 - 55 °C</b>	<b>-10 - 55 °C</b>
<b>Storage temperature</b>			
Temperature range	<b>-40 - 85 °C</b>	<b>-40 - 85 °C</b>	<b>-40 - 85 °C</b>

<b>Environmental data</b>	<b>750104</b>	<b>750134</b>	<b>751104</b>
Climatic suitability			
Humidity	93 % r. h. at 40 °C	93 % r. h. at 40 °C	93 % r. h. at 40 °C
Condensation during operation			
	Not permitted	Not permitted	Not permitted
EMC			
	EN 60947-5-1, EN 61000-6-2, EN 61000-6-4, EN 61326-3-1	EN 60947-5-1, EN 61000-6-2, EN 61000-6-4, EN 61326-3-1	EN 60947-5-1, EN 61000-6-2, EN 61000-6-4, EN 61326-3-1
Vibration			
in accordance with the standard	EN 60068-2-6	EN 60068-2-6	EN 60068-2-6
Frequency	10 - 55 Hz	10 - 55 Hz	10 - 55 Hz
Amplitude	0,35 mm	0,35 mm	0,35 mm
Airgap creepage			
in accordance with the standard	EN 60947-1	EN 60947-1	EN 60947-1
Overvoltage category	III / II	III / II	III / II
Pollution degree	2	2	2
Rated insulation voltage			
	250 V	250 V	250 V
Rated impulse withstand voltage			
	4 kV	4 kV	4 kV
Protection type			
Housing	IP40	IP40	IP40
Terminals	IP20	IP20	IP20
Mounting area (e.g. control cabinet)	IP54	IP54	IP54
<b>Mechanical data</b>	<b>750104</b>	<b>750134</b>	<b>751104</b>
Mounting position			
	Any	Any	Any
Mechanical life			
	10,000,000 cycles	10,000,000 cycles	10,000,000 cycles
Material			
Bottom	PC	PC	PC
Front	PC	PC	PC
Top	PC	PC	PC
Connection type			
	Screw terminal	Screw terminal	Spring-loaded terminal
Mounting type			
	plug-in	plug-in	plug-in
Conductor cross section with screw terminals			
1 core flexible	0,25 - 2,5 mm <sup>2</sup> , 24 - 12 AWG	0,25 - 2,5 mm <sup>2</sup> , 24 - 12 AWG	—
2 core with the same cross section, flexible with crimp connectors, no plastic sleeve	0,25 - 1 mm <sup>2</sup> , 24 - 16 AWG	0,25 - 1 mm <sup>2</sup> , 24 - 16 AWG	—
2 core with the same cross section, flexible without crimp connectors or with TWIN crimp connectors	0,2 - 1,5 mm <sup>2</sup> , 24 - 16 AWG	0,2 - 1,5 mm <sup>2</sup> , 24 - 16 AWG	—

<b>Mechanical data</b>	<b>750104</b>	<b>750134</b>	<b>751104</b>
Torque setting with screw terminals	<b>0,5 Nm</b>	<b>0,5 Nm</b>	–
Stripping length with screw terminals	<b>8 mm</b>	<b>8 mm</b>	–
Conductor cross section with spring-loaded terminals: Flexible with/without crimp connector	–	–	<b>0,2 - 2,5 mm<sup>2</sup>, 24 - 12 AWG</b>
Spring-loaded terminals: Terminal points per connection	–	–	<b>2</b>
Stripping length with spring-loaded terminals	–	–	<b>9 mm</b>
<b>Dimensions</b>			
Height	<b>98 mm</b>	<b>98 mm</b>	<b>100 mm</b>
Width	<b>22,5 mm</b>	<b>22,5 mm</b>	<b>22,5 mm</b>
Depth	<b>120 mm</b>	<b>120 mm</b>	<b>120 mm</b>
Weight	<b>185 g</b>	<b>210 g</b>	<b>185 g</b>

Where standards are undated, the 2022-09 latest editions shall apply.

### Technical details Order no. 751134, 751184

<b>General</b>	<b>751134</b>	<b>751184</b>
Certifications	CCC, CE, EAC, KOSHA, TÜV, UKCA, cULus Listed	CCC, CE, EAC, KOSHA, TÜV, UKCA, cULus Listed
<b>Electrical data</b>	<b>751134</b>	<b>751184</b>
Supply voltage		
Voltage	<b>48 - 240 V</b>	<b>24 V</b>
Kind	<b>AC/DC</b>	<b>DC</b>
Voltage tolerance	<b>-15 %/+10 %</b>	<b>-15 %/+10 %</b>
Output of external power supply (AC)	<b>5 VA</b>	–
Output of external power supply (DC)	<b>2,5 W</b>	<b>2,5 W</b>
Frequency range AC	<b>50 - 60 Hz</b>	–
Residual ripple DC	<b>160 %</b>	<b>20 %</b>
Duty cycle	<b>100 %</b>	<b>100 %</b>
Max. inrush current impulse		
Current pulse, A1	–	<b>0,5 A</b>
Pulse duration, A1	–	<b>5 ms</b>
<b>Inputs</b>	<b>751134</b>	<b>751184</b>
Quantity	<b>2</b>	<b>2</b>
Voltage at		
Input circuit DC	<b>24 V</b>	<b>24 V</b>
Start circuit DC	<b>24 V</b>	<b>24 V</b>
Feedback loop DC	<b>24 V</b>	<b>24 V</b>
Current at		
Input circuit DC	<b>50 mA</b>	<b>50 mA</b>
Start circuit DC	<b>50 mA</b>	<b>50 mA</b>
Feedback loop DC	<b>50 mA</b>	<b>50 mA</b>
Max. inrush current impulse		
Current pulse, input circuit	<b>0,2 A</b>	<b>0,2 A</b>
Pulse duration, input circuit	<b>100 ms</b>	<b>100 ms</b>
Current pulse, feedback loop	<b>0,2 A</b>	<b>0,2 A</b>
Pulse duration, feedback loop	<b>15 ms</b>	<b>15 ms</b>
Current pulse, start circuit	<b>0,2 A</b>	<b>0,2 A</b>
Pulse duration, start circuit	<b>15 ms</b>	<b>15 ms</b>
Min. input resistance at power-on	<b>110 Ohm</b>	<b>110 Ohm</b>

<b>Inputs</b>	<b>751134</b>	<b>751184</b>
Max. overall cable resistance Rl-max		
Single-channel at UB DC	<b>30 Ohm</b>	<b>30 Ohm</b>
Single-channel at UB AC	<b>30 Ohm</b>	–
Dual-channel without detection of shorts across contacts at UB DC	<b>30 Ohm</b>	<b>60 Ohm</b>
Dual-channel without detection of shorts across contacts at UB AC	<b>30 Ohm</b>	–
Dual-channel with detection of shorts across contacts at UB DC	<b>30 Ohm</b>	<b>30 Ohm</b>
Dual-channel with detection of shorts across contacts at UB AC	<b>30 Ohm</b>	–
<b>Semiconductor outputs</b>	<b>751134</b>	<b>751184</b>
Quantity	<b>1</b>	<b>1</b>
Voltage	<b>24 V</b>	<b>24 V</b>
Current	<b>20 mA</b>	<b>20 mA</b>
Residual current at "0" signal	<b>0,1 mA</b>	<b>0,1 mA</b>
Max. internal voltage drop	–	<b>5 V</b>
Conditional rated short circuit current	<b>100 A</b>	<b>100 A</b>
Lowest operating current	<b>0 mA</b>	<b>0 mA</b>
Utilisation category in accordance with EN 60947-1	<b>DC-12</b>	<b>DC-12</b>
<b>Relay outputs</b>	<b>751134</b>	<b>751184</b>
Number of output contacts		
Safety contacts (N/O), instantaneous	<b>3</b>	<b>3</b>
Auxiliary contacts (N/C)	<b>1</b>	<b>1</b>
Max. short circuit current I <sub>K</sub>	<b>1 kA</b>	<b>1 kA</b>
Utilisation category		
in accordance with the standard	<b>EN 60947-4-1</b>	<b>EN 60947-4-1</b>
Utilisation category of safety contacts		
AC1 at	<b>240 V</b>	<b>240 V</b>
Min. current	<b>0,003 A</b>	<b>0,003 A</b>
Max. current	<b>6 A</b>	<b>6 A</b>
Min. power	<b>0,04 VA</b>	<b>0,04 VA</b>
Max. power	<b>1500 VA</b>	<b>1500 VA</b>
DC1 at	<b>24 V</b>	<b>24 V</b>
Min. current	<b>0,003 A</b>	<b>0,003 A</b>
Max. current	<b>6 A</b>	<b>6 A</b>
Min. power	<b>0,04 W</b>	<b>0,04 W</b>
Max. power	<b>150 W</b>	<b>150 W</b>

<b>Relay outputs</b>	<b>751134</b>	<b>751184</b>
Utilisation category of auxiliary contacts		
AC1 at	<b>240 V</b>	<b>240 V</b>
Min. current	<b>0,003 A</b>	<b>0,003 A</b>
Max. current	<b>6 A</b>	<b>6 A</b>
Min. power	<b>0,04 VA</b>	<b>0,04 VA</b>
Max. power	<b>1500 VA</b>	<b>1500 VA</b>
DC1 at	<b>24 V</b>	<b>24 V</b>
Min. current	<b>0,003 A</b>	<b>0,003 A</b>
Max. current	<b>6 A</b>	<b>6 A</b>
Min. power	<b>0,04 W</b>	<b>0,04 W</b>
Max. power	<b>150 W</b>	<b>150 W</b>
Utilisation category in accordance with the standard <b>EN 60947-5-1</b>		
Utilisation category of safety contacts		
AC15 at	<b>230 V</b>	<b>230 V</b>
Max. current	<b>3 A</b>	<b>5 A</b>
DC13 (6 cycles/min) at	<b>24 V</b>	<b>24 V</b>
Max. current	<b>4 A</b>	<b>5 A</b>
Utilisation category of auxiliary contacts		
AC15 at	<b>230 V</b>	<b>230 V</b>
Max. current	<b>3 A</b>	<b>5 A</b>
DC13 (6 cycles/min) at	<b>24 V</b>	<b>24 V</b>
Max. current	<b>4 A</b>	<b>5 A</b>
Utilisation category in accordance with UL		
Voltage with current	<b>240 V AC G.U. (same polarity)</b>	<b>240 V AC G.U. (same polarity)</b>
Voltage with current	<b>24 V DC G. U.</b>	<b>24 V DC G. U.</b>
External contact fuse protection, safety contacts		
in accordance with the standard	<b>EN 60947-5-1</b>	<b>EN 60947-5-1</b>
Max. melting integral	<b>66 A<sup>2</sup>s</b>	<b>260 A<sup>2</sup>s</b>
Blow-out fuse, quick	<b>6 A</b>	<b>10 A</b>
Blow-out fuse, slow	<b>4 A</b>	<b>6 A</b>
Blow-out fuse, gG	<b>6 A</b>	<b>10 A</b>
Circuit breaker 24V AC/DC, characteristic B/C	<b>4 A</b>	<b>6 A</b>

<b>Relay outputs</b>	<b>751134</b>	<b>751184</b>
External contact fuse protection, auxiliary contacts		
Max. melting integral	<b>66 A<sup>2</sup>s</b>	<b>160 A<sup>2</sup>s</b>
Blow-out fuse, quick	<b>6 A</b>	<b>10 A</b>
Blow-out fuse, slow	<b>4 A</b>	<b>6 A</b>
Blow-out fuse, gG	<b>6 A</b>	<b>6 A</b>
Circuit breaker, 24 V AC/DC, characteristic B/C	<b>4 A</b>	<b>6 A</b>
Contact material	<b>AgCuNi + 0,2 µm Au</b>	<b>AgCuNi + 0,2 µm Au</b>
<b>Conventional thermal current while loading several contacts</b>	<b>751134</b>	<b>751184</b>
I <sub>th</sub> per contact at UB AC; AC1: 240 V, DC1: 24 V		
Conv. therm. current with 1 contact	<b>6 A</b>	–
Conv. therm. current with 2 contacts	<b>6 A</b>	–
Conv. therm. current with 3 contacts	<b>4,5 A</b>	–
I <sub>th</sub> per contact at UB DC; AC1: 240 V, DC1: 24 V		
Conv. therm. current with 1 contact	<b>6 A</b>	<b>6 A</b>
Conv. therm. current with 2 contacts	<b>6 A</b>	<b>6 A</b>
Conv. therm. current with 3 contacts	<b>4,5 A</b>	<b>5 A</b>
<b>Times</b>	<b>751134</b>	<b>751184</b>
Switch-on delay		
with automatic start typ.	<b>170 ms</b>	<b>170 ms</b>
with automatic start max.	<b>300 ms</b>	<b>300 ms</b>
with automatic start after power on typ.	<b>350 ms</b>	<b>350 ms</b>
with automatic start after power on max.	<b>600 ms</b>	<b>600 ms</b>
with manual start typ.	<b>40 ms</b>	<b>40 ms</b>
with manual start max.	–	<b>300 ms</b>
with monitored start with rising edge typ.	<b>35 ms</b>	<b>35 ms</b>
with monitored start with rising edge max.	<b>50 ms</b>	<b>50 ms</b>
with monitored start with falling edge typ.	<b>55 ms</b>	<b>55 ms</b>
with monitored start with falling edge max.	<b>70 ms</b>	<b>70 ms</b>



<b>Times</b>	<b>751134</b>	<b>751184</b>
Delay-on de-energisation		
with E-STOP typ.	<b>10 ms</b>	<b>10 ms</b>
with E-STOP max.	<b>20 ms</b>	<b>20 ms</b>
with power failure typ.	<b>40 ms</b>	<b>40 ms</b>
with power failure max.	<b>80 ms</b>	<b>80 ms</b>
Recovery time at max. switching frequency 1/s		
after E-STOP	<b>50 ms</b>	<b>100 ms</b>
after power failure	<b>100 ms</b>	<b>100 ms</b>
Waiting period with a monitored start		
with rising edge	<b>120 ms</b>	<b>120 ms</b>
with falling edge	<b>150 ms</b>	<b>250 ms</b>
Min. start pulse duration with a monitored start		
with falling edge	<b>100 ms</b>	<b>100 ms</b>
with rising edge	<b>30 ms</b>	<b>30 ms</b>
Supply interruption before de-energisation	<b>20 ms</b>	<b>20 ms</b>
Simultaneity, channel 1 and 2 max.	$\infty$	$\infty$
<b>Environmental data</b>	<b>751134</b>	<b>751184</b>
Climatic suitability	<b>EN 60068-2-78</b>	<b>EN 60068-2-78</b>
Ambient temperature		
Temperature range	<b>-10 - 55 °C</b>	<b>-25 - 55 °C</b>
Storage temperature		
Temperature range	<b>-40 - 85 °C</b>	<b>-40 - 85 °C</b>
Climatic suitability		
Humidity	<b>93 % r. h. at 40 °C</b>	<b>93 % r. h. at 40 °C</b>
Condensation during operation	<b>Not permitted</b>	<b>Not permitted</b>
EMC	<b>EN 60947-5-1, EN 61000-6-2, EN 61000-6-4, EN 61326-3-1</b>	<b>EN 60947-5-1, EN 61000-6-2, EN 61000-6-4, EN 61326-3-1</b>
Vibration		
in accordance with the standard	<b>EN 60068-2-6</b>	<b>EN 60068-2-6</b>
Frequency	<b>10 - 55 Hz</b>	<b>10 - 55 Hz</b>
Amplitude	<b>0,35 mm</b>	<b>0,35 mm</b>
Airgap creepage		
in accordance with the standard	<b>EN 60947-1</b>	<b>EN 60947-1</b>
Overvoltage category	<b>III / II</b>	<b>III / II</b>
Pollution degree	<b>2</b>	<b>2</b>
Rated insulation voltage	<b>250 V</b>	<b>250 V</b>
Rated impulse withstand voltage	<b>4 kV</b>	<b>4 kV</b>
Protection type		
Housing	<b>IP40</b>	<b>IP40</b>
Terminals	<b>IP20</b>	<b>IP20</b>
Mounting area (e.g. control cabinet)	<b>IP54</b>	<b>IP54</b>

<b>Mechanical data</b>	<b>751134</b>	<b>751184</b>
Mounting position	<b>Any</b>	<b>Any</b>
Mechanical life	<b>10,000,000 cycles</b>	<b>10,000,000 cycles</b>
Material		
Bottom	<b>PC</b>	<b>PC</b>
Front	<b>PC</b>	<b>PC</b>
Top	<b>PC</b>	<b>PC</b>
Connection type	<b>Spring-loaded terminal</b>	<b>Spring-loaded terminal</b>
Mounting type	<b>plug-in</b>	<b>plug-in</b>
Conductor cross section with spring-loaded terminals: Flexible with/without crimp connector	<b>0,2 - 2,5 mm<sup>2</sup>, 24 - 12 AWG</b>	<b>0,2 - 2,5 mm<sup>2</sup>, 24 - 12 AWG</b>
Spring-loaded terminals: Terminal points per connection	<b>2</b>	<b>2</b>
Stripping length with spring-loaded terminals	<b>9 mm</b>	<b>9 mm</b>
Dimensions		
Height	<b>100 mm</b>	<b>100 mm</b>
Width	<b>22,5 mm</b>	<b>22,5 mm</b>
Depth	<b>120 mm</b>	<b>120 mm</b>
Weight	<b>210 g</b>	<b>190 g</b>

Where standards are undated, the 2022-09 latest editions shall apply.

## Safety characteristic data



### NOTICE

You must comply with the safety characteristic data in order to achieve the required safety level for your plant/machine.

Operating mode	EN ISO 13849-1: 2015	EN ISO 13849-1: 2015	EN IEC 62061 SIL CL/ maximum SIL	EN IEC 62061 PFH <sub>D</sub> [1/h]	EN/IEC 61511 SIL	EN/IEC 61511 PFD	EN ISO 13849-1: 2015 T <sub>M</sub> [year]
	PL e	Cat. 4	SIL 3	2,31E-09	SIL 3	2,03E-06	20

Safety contacts, instantaneous

PL e      Cat. 4      SIL 3      2,31E-09      SIL 3      2,03E-06      20

Explanatory notes for the safety-related characteristic data:

- ▶ Safety characteristic data in accordance with EN IEC 62061 and EN/IEC 61511 was calculated based on EN/IEC 61508.
- ▶ T<sub>M</sub> is the maximum mission time in accordance with EN ISO 13849-1. The value also applies as the retest interval in accordance with EN/IEC 61508-6 and EN/IEC 61511 and as the proof test interval and mission time in accordance with EN IEC 62061.

All the units used within a safety function must be considered when calculating the safety characteristic data.



### INFORMATION

A safety function's SIL/PL values are **not** identical to the SIL/PL values of the units that are used and may be different. We recommend that you use the PAScal software tool to calculate the safety function's SIL/PL values.

## Classification according to ZVEI, CB24I

The following tables describe the classes and specific values of the product interface and the classes of interfaces compatible with it. The classification is described in the ZVEI position paper "Classification of Binary 24 V Interfaces - Functional Safety aspects covered by dynamic testing".

### Input

#### Interfaces

##### Drain

Interface	Module
Class	C0

##### Source

Interface	Sensor
Class	C1, C2, C3

#### Drain parameters

Max. test pulse duration	2 ms
Min. input resistance	0,5 kOhm
Max. capacitive load	10 nF

### Relay outputs

#### Interfaces

##### Source

Interface	Module
Class	A

##### Drain

Interface	Actuator
Class	A

#### Source parameters

Min. switching voltage	12 V
Max. switching voltage	250 V
Min. switching current	0,003 A
Max. switching current	6 A
Potential isolation	Yes

### Supplementary data



**CAUTION!**

It is essential to consider the relay's service life graphs. The relay outputs' safety-related characteristic data is only valid if the values in the service life graphs are met.

The PFH value depends on the switch frequency and the load of the relay output. If the service life graphs are not accessible, the stated PFH value can be used irrespective of the switch frequency and the load, as the PFH value already considers the relay's B10d value as well as the failure rates of the other components.

**Service life graph**

The service life graphs indicate the number of cycles from which failures due to wear must be expected. The wear is mainly caused by the electrical load; the mechanical load is negligible.

Unit types with UB 24 VDC

- ▶ U<sub>B</sub>: 24 VDC; Order no. 750104, 751104, 751184

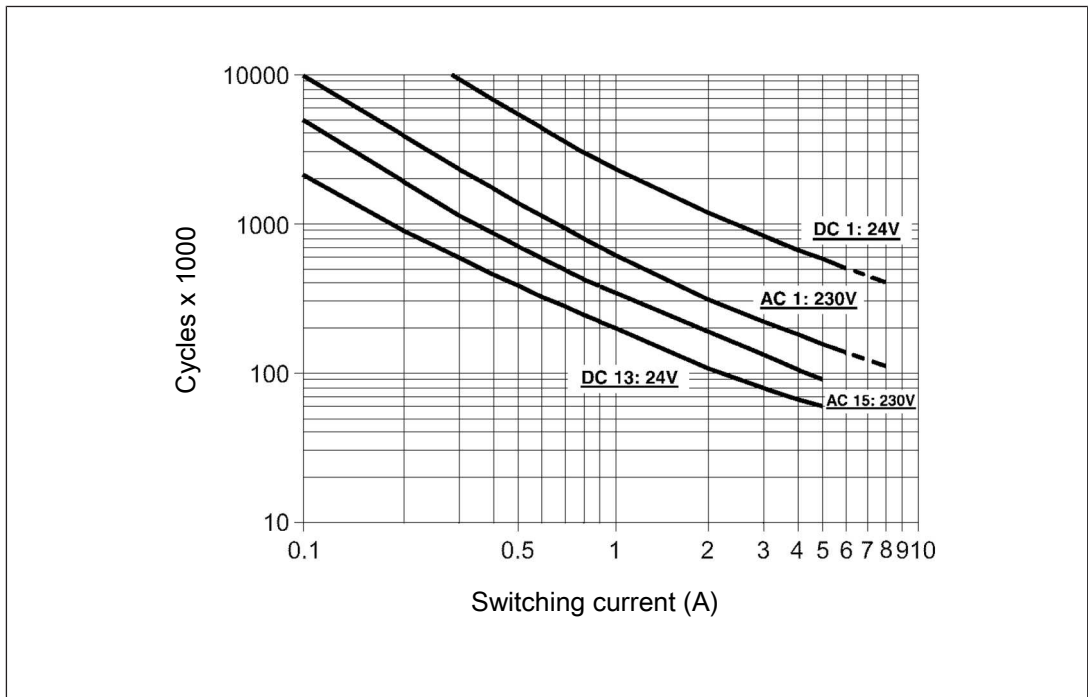

Fig.: Service life graphs at 24 V DC and 230 V AC

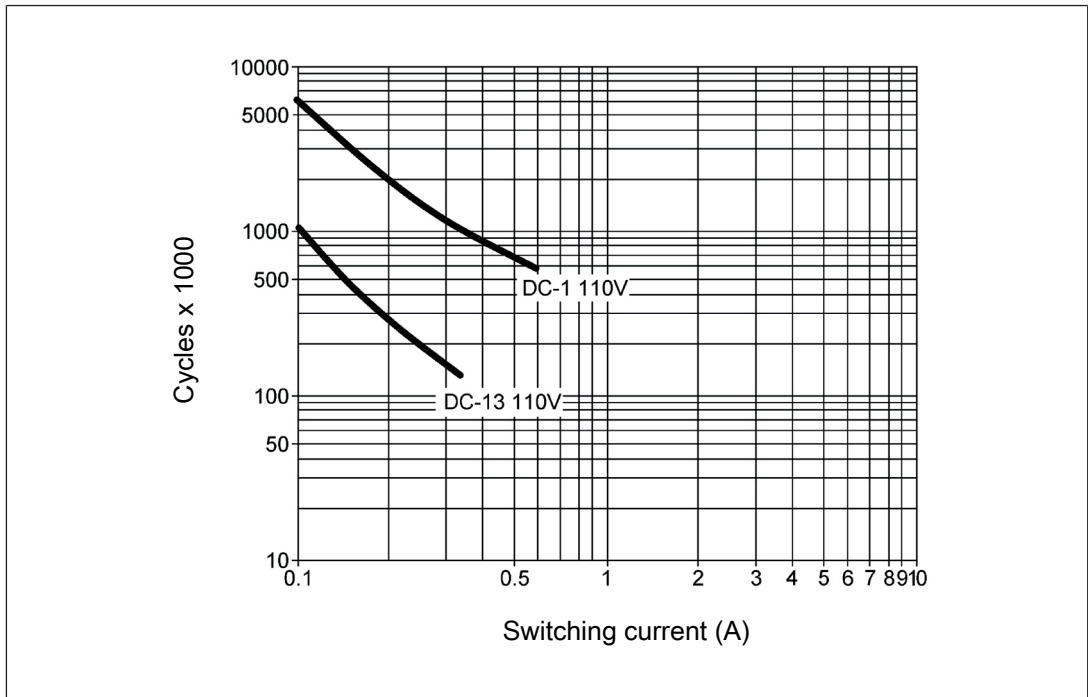

Fig.: Service life graphs at 110 V DC

**Example**

- ▶ Inductive load: 0.2 A
- ▶ Utilisation category: AC15
- ▶ Contact service life: 2 000 000 cycles

Provided the application to be implemented requires fewer than 2 000 000 cycles, the PFH value (see [Technical details \[📖 22\]](#)) can be used in the calculation.

To increase the service life, sufficient spark suppression must be provided on all output contacts. With capacitive loads, any power surges that occur must be noted. With DC contactors, use flywheel diodes for spark suppression.

Unit types with UB 48-240 VAC/DC

►  $U_B$ : 48 – 240 VAC/DC; Order no. 750134, 751134

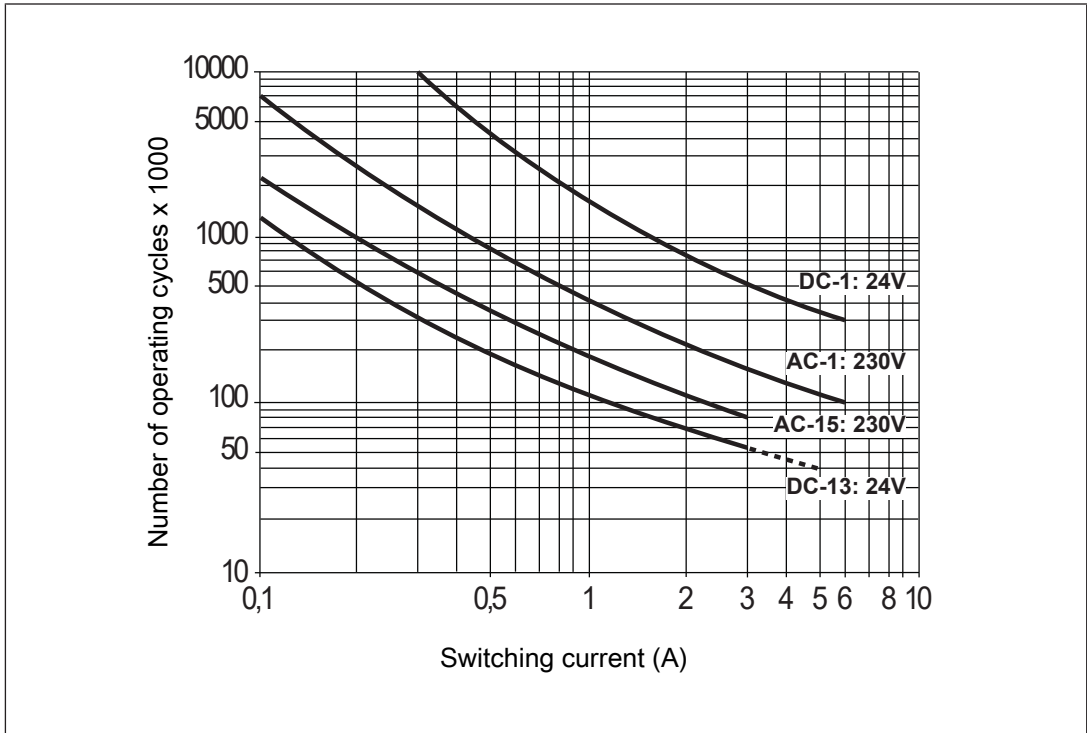

Fig.: Service life graphs at 24 VDC and 230 VAC

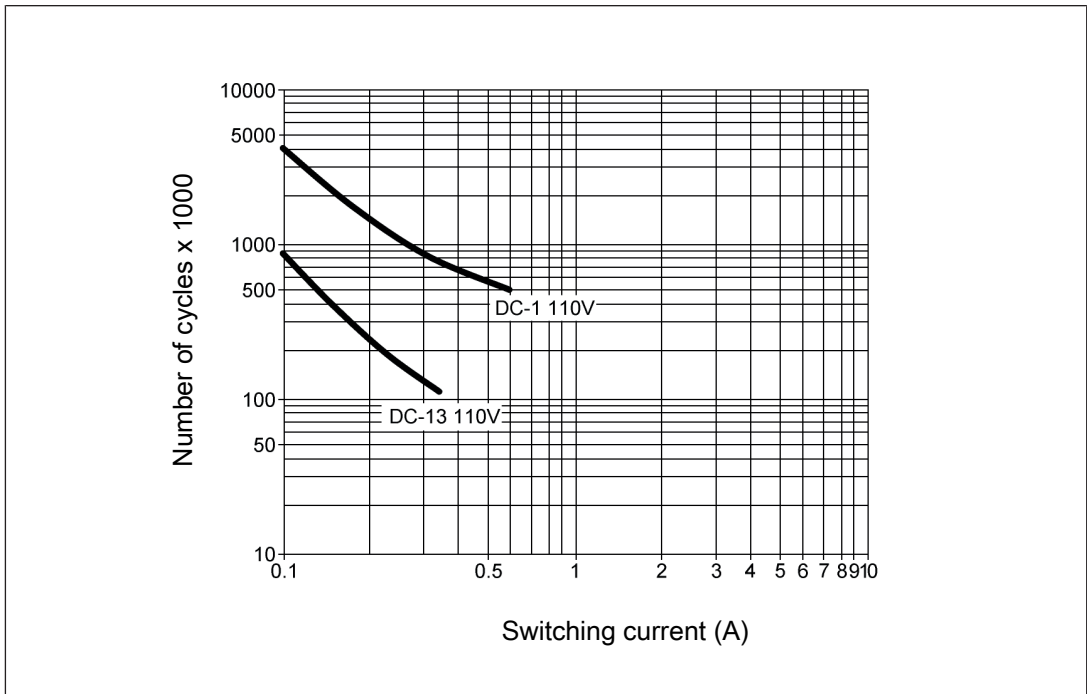

Fig.: Service life graphs at 110 VDC

**Example**

- ▶ Inductive load: 0.2 A
- ▶ Utilisation category: AC15
- ▶ Contact service life: 1 000 000 cycles

Provided the application to be implemented requires fewer than 1 000 000 cycles, the PFH value (see [Technical details \[📖 22\]](#)) can be used in the calculation.

To increase the service life, sufficient spark suppression must be provided on all relay contacts. With capacitive loads, any power surges that occur must be noted. With DC contactors, use flywheel diodes for spark suppression.



### Permitted operating height

The values stated in the technical details apply to the use of the device in operating heights up to max. 2000 m above sea level. When used in greater heights, constraints have to be taken into account:

- ▶ Permitted maximum operating height 5000 m
- ▶ Only device versions with UB 24 V DC are permitted (order no. 750104, 751104, 751184)
- ▶ Reduction of rated insulation voltage and rated impulse withstand voltage for applications with safe separation:

Maximum operation height	Rated insulation voltage	Overvoltage category	Max. rated impulse withstand voltage
3000 m	150 V	II	2.5 kV
	100 V	III	2.5 kV
4000 m	150 V	II	2.5 kV
	100 V	III	2.5 kV
5000 m	100 V	II	1.5 kV
	24 V	III	0.8 kV

- ▶ Reduction of rated insulation voltage and rated impulse withstand voltage for applications with basic insulation:

Maximum operation height	Rated insulation voltage	Overvoltage category	Max. rated impulse withstand voltage
3000 m	250 V	II	2.5 kV
	150 V	III	2.5 kV
4000 m	250 V	II	2.5 kV
	150 V	III	2.5 kV
5000 m	150 V	II	1.5 kV
	100 V	III	1.5 kV

- ▶ From an operating height of 2000 m the max. permitted ambient temperature is reduced by 0.5 °C/100 m

Operating height	Permitted ambient temperature
3000 m	50 °C
4000 m	45 °C
5000 m	40 °C

## Remove plug-in terminals

### Procedure

► Insert a suitable screwdriver into the housing recess behind the terminal.

Do **not** remove the terminals by pulling the cables!

► Lever the terminal out.

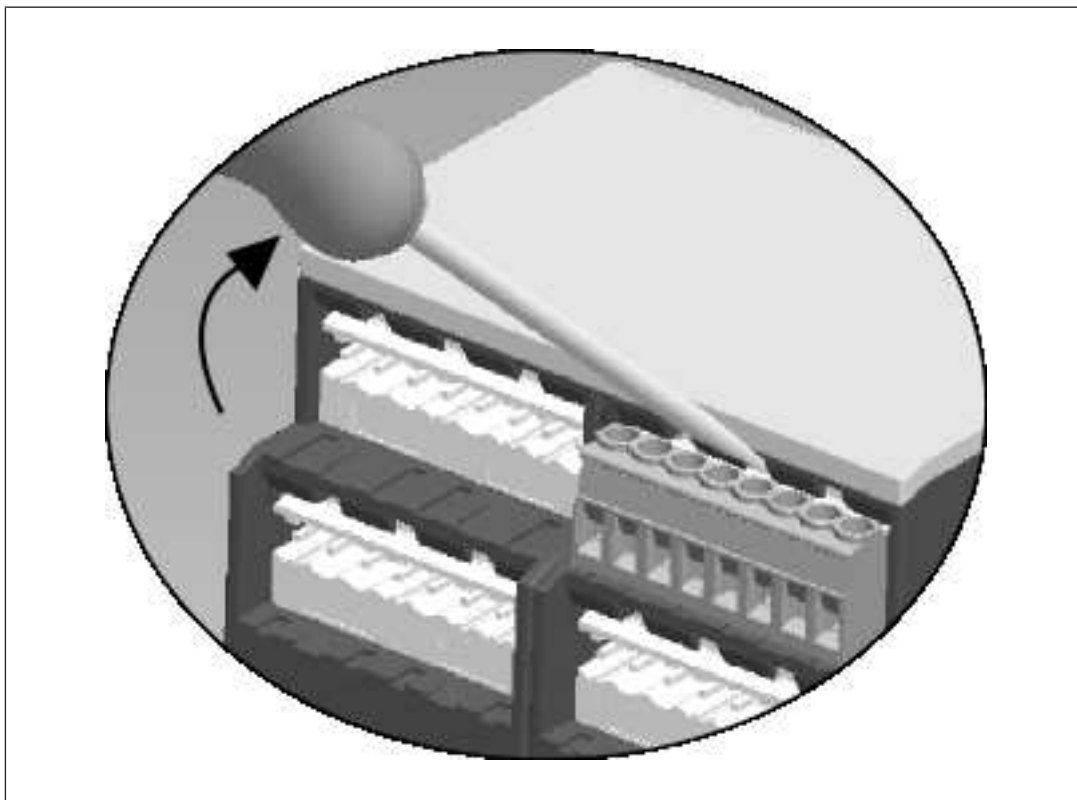

### Order reference

Product type	Features	Connection type	Order no.
PNOZ s4	24 V DC	Screw terminals	750104
PNOZ s4	48 – 240 VAC/DC	Screw terminals	750134
PNOZ s4 C	24 V DC	Spring-loaded terminals	751104
PNOZ s4 C	48 – 240 VAC/DC	Spring-loaded terminals	751134
PNOZ s4 C Coated	24 V DC	Spring-loaded terminals	751184

### EC declaration of conformity

This product/these products meet the requirements of the directive 2006/42/EC for machinery of the European Parliament and of the Council. The complete EC Declaration of Conformity is available on the Internet at [www.pilz.com/downloads](http://www.pilz.com/downloads).

Authorised representative: Norbert Fröhlich, Pilz GmbH & Co. KG, Felix-Wankel-Str. 2, 73760 Ostfildern, Germany

### **UKCA-Declaration of Conformity**

This product(s) complies with following UK legislation: Supply of Machinery (Safety) Regulation 2008.

The complete UKCA Declaration of Conformity is available on the Internet at [www.pilz.com/downloads](http://www.pilz.com/downloads).

Representative: Pilz Automation Technology, Pilz House, Little Colliers Field, Corby, Northamptonshire, NN18 8TJ United Kingdom, eMail: [mail@pilz.co.uk](mailto:mail@pilz.co.uk)

